

Mn/DOT Access Management Guidelines
Background Technical Report

Access Operations Study:
Analysis of Traffic Signal Spacing on Four Lane
Arterials

November 2002

Minnesota Department of Transportation
Office of Investment Management
Access Management Unit

Study Overview

Summary Overview

One of the key issues addressed in the Access Management Guidelines adopted by Mn/DOT in July 2002 (Technical Memorandum No. 02-10-1M-01) is the spacing of public intersections on trunk highways within urban/urbanizing areas. The issue arises because within urban/urbanizing areas, the highway must serve two different and somewhat competing functions: mobility and access. Mobility is important to the longer distance traveler who seeks to maintain travel speeds through urban areas, and minimize stops at signalized intersections. Access is important to the local residents and businesses that also want quick and convenient movement to, from, and across the highway to destinations within their community. What intersection spacing provides the optimal balance between these two competing functions of mobility and access?

A review of the literature and the practice of other states indicated that a one-half mile spacing of intersections on arterials within urban areas is generally recommended. The one-half mile spacing provides the opportunity to promote coordinated signal progression at a reasonable through speed (approximately 45 mph with long cycle lengths) while keeping the through traffic moving within a platoon. At intersection spacing greater than one-half mile, platoon dispersal becomes increasingly apparent.

Current literature does not specifically discuss how intersection spacing affects the traffic operations of the larger local street network. However, many other states report that one-quarter mile spacing is often necessary to provide acceptable levels of access, and that signal progression at lower speeds can still be achieved. The spacing of intersections at one-mile or greater was seen as providing greater mobility for through traffic, but in most cases, viewed as unattainable due to the negative impacts on the adjacent land use and street networks.

Intersection Spacing on Interregional Corridors and Regional Corridors

In developing the Access Management Guidelines, intersection spacing through urban/urbanizing areas on Medium Priority Interregional Corridors (*Access Category 2*) and High Priority Regional Corridors (*Access Category 3*) was a special concern given the special role these roadways serve in linking the regional trade centers to one another and to the Twin Cities Metro Area. Performance standards for mobility on these roadways have been established in terms of maintaining average corridor-wide travel speeds. Since each public intersection on an at-grade highway has the potential to be signalized, and each signal represents a potential time delay for through trips, limiting intersections in urbanizing areas through increased spacing was viewed as a means to prevent signal proliferation and maintain corridor travel speeds.

However as these highways extend in and through the trade centers, they must also provide a reasonable level of access to the goods and services located in the trade centers. At what point does limiting access through greater intersection spacing begin to have a negative impact on the mobility and travel times of those trips to, from, and within the trade center?

Study Approach

The Access Operations Study was initiated to address these issues. The study involved developing a small-area traffic model to assess the operational differences for one-quarter mile, one-half mile, and one-mile signalized intersection spacing alternatives on two theoretical corridor settings typical of IRC and Regional Corridors in the state.

The first corridor setting represented a three-mile small-to-medium size freestanding urban center. The second corridor setting represented a ten-mile corridor through a developing suburban area on the fringe of the Metro Area. Both of these corridors were set in the context of a 65-mile corridor so that the impacts of the various signal spacing could be compared against the travel time targets established for Interregional Corridors and Regional Corridors.

Land use and the supporting road network were held constant under the alternative intersection spacing scenarios.

The traffic model provided numerous outputs or measures that could be used to compare the alternative signalized intersection spacing scenarios. However, since the goal of the study was to determine the optimal balance between mobility and access on these roadways, two primary performance measures were analyzed: total mainline travel time and overall system user costs

Total mainline travel is the time it would take for users to make the entire 65-mile trip from end of the larger corridor to the other. These times were then converted to travel speed and compared to the Interregional Corridor (IRC) and Regional Corridor (RC) speed targets.

Performance Targets for Interregional Corridors and Regional Corridors

Performance Targets (Statewide IRC Policies, Sept 2000)	65-Mile Corridor		
	High Priority IRC	Medium Priority IRC	High Priority RC
Travel Time at Target Speed (min)	65.0	70.9	78.0
Mainline Target Speed (mph)	60.0	55.0	50.0

Overall system user costs assess the overall efficiency of the system in accommodating all trips, both through trips and local trips (with origin and/or destination) within the local community. To obtain this measure, outputs from the model such as Vehicle-Hours-Traveled (VHT), Vehicle-Miles-Traveled (VMT), and number of stops were combined using benefit-cost methodologies to obtain an overall economic measure for a peak hour time period.

Study Results

In general, the study results indicated that the one-half mile intersection spacing in urban/urbanizing areas provides the optimal balance between mobility and access. This conclusion was reached for both the Freestanding Urban Setting scenario and the 10-Mile Commuter Corridor scenario. Although the analysis was conducted for a four-lane divided arterial, similar results would be expected on a two-lane roadway.

Performance Measure Results for the Freestanding Urban Center

Evaluation Measure	Signal Spacing for Three Mile Network		
	¼ Mile	½ Mile	1 Mile
Mainline Travel Time (minutes)	62.7	61.8	61.3
Average Mainline speed (mph)	62.2	63.1	63.6
User Cost (dollars)	\$5,527	\$5,538	\$7,026

For the Freestanding Urban Center setting, the one-mile intersection spacing provided a slightly higher average mainline speed for the through trips (0.5 to 1.4 mph increase) but this only provided a minimal reduction (0.5 to 1.4 minutes) in overall travel time for the overall 65-mile trip. At the same time, the impact on the travel costs of total system users increased over 27% compared to the one-quarter mile and one-half mile spacing. Under all intersections spacing options, the mobility performance targets for Interregional Corridors and Regional Corridors would be maintained.

Performance Measure Results for the 10-Mile Commuter Corridor

Evaluation Measure	Signal Spacing	
	½ Mile	1 Mile
Mainline Travel Time (minutes)	63.2	62.4
Average Mainline speed (mph)	61.7	62.5
User Cost (dollars)	\$23,400	\$29,700

For the 10 mile Commuter Corridor, the analysis produced similar results. The one-mile intersection spacing provided only minimal improvement in mainline travel speed and corridor travel time compared to the one-half mile spacing while significantly increasing total system user costs.

Several reasons explain why the one-mile signal spacing does not produce significant mobility benefits compared to the one-half mile spacing. Through traffic signal progression and green bandwidth was easier to achieve on one-half mile spacing than on one-mile spacing due to:

- Platoon dispersion
- Concentration of mainline lefts at fewer intersections
- Concentration of side street volumes
- Queue clearance from upstream intersection movements

Further limiting the number of intersections from one-half mile to one-mile results in greater numbers of turning and cross-street vehicles at the remaining intersections. The increased volume of these movements generally requires additional green time thus limiting the green time available for mainline through vehicles.

Implications for Access Management Guideline Applications

Mn/DOT's Access Management Guidelines set one-half mile distance as the desirable spacing between full-movement intersections in urban/urbanizing areas for Interregional Corridors and Regional Corridors as well as for Principal Arterials within Primary Trade Centers. Greater spacing between intersections within urban/urbanizing areas is only advised if there is a clearly demonstrated existing or projected corridor-wide mobility performance issue. On Interregional Corridors where the corridor analysis indicates future mobility issues, consideration should be given to managing the corridor under the guidelines as a future fully-grade separated roadway (*Subcategory A-F*) rather than simply increasing the distance between at-grade intersections. On Regional Corridors and Principal Arterials, where conversion of the arterial to a fully grade-separated facility is not part of the 20-year long-range investment plan, planning and management of the roadway in urban/urbanizing areas around the smaller trade centers and Metro Area fringe should aim for the one-half mile spacing target. For urban/urbanizing areas, one-half mile spacing of full-movement intersections should maintain mobility for through trips without imposing undue travel costs on total system users.

ACCESS OPERATIONS STUDY

ANALYSIS OF TRAFFIC SIGNAL SPACING ON FOUR LANE ARTERIALS

Prepared for
Mn/DOT OIM

Prepared by
SRF Consulting Group, Inc.
One Carlson Parkway North, Suite 150
Minneapolis, MN 55447-4443
Phone: 763-475-0010
Fax: 763-475-2429

November 2002

SRF No. 0014085

TABLE OF CONTENTS

	<u>Page</u>
Introduction	1
Study Approach	2
Land Use and Trip Generation Methodology	2
Network Assumptions.....	6
Network Assignment	10
Network Forecasts	12
Traffic Operations Analysis Methodology	12
Performance Measures	17
Analysis Results	19
Freestanding Community.....	19
Ten-Mile commuter Corridor	22
What If Analysis	23
Appendix A: Additional Traffic Information	
Appendix B: Glossary Of Terms	

LIST OF FIGURES

	<u>Page</u>
Figure 1 Study Context – Freestanding Urban Center	3
Figure 2 Study Context – Commuter Corridor.....	4
Figure 3 Local Land Use Assumptions – Freestanding Urban Center.....	5
Figure 4 Model Framework – Quarter-Mile Signal Spacing Scenario	7
Figure 5 Model Framework – Half-Mile Signal Spacing Scenario.....	8
Figure 6 Model Framework – One-Mile Signal Spacing Scenario.....	9
Figure 7 Trip Patterns.....	11
Figure 8 Mainline Volumes: Quarter-Mile Signal Spacing	13
Figure 9 Mainline Volumes: Half-Mile Signal Spacing	14
Figure 10 Mainline Volumes: One-Mile Signal Spacing.....	15
Figure 11 Quarter-Mile Signal Spacing – Disconnected Service Road	24
Figure 12 Half-Mile Signal Spacing – Disconnected Service Road	25
Figure 13 One-Mile Signal Spacing – Disconnected Service Road.....	26
Figure 14 Mainline Volume Changes – 1/4 Mile Signal Spacing.....	28
Figure 15 Mainline Volume Changes – 1/2 Mile Signal Spacing.....	29
Figure 16 Mainline Volume Changes – 1 Mile Signal Spacing.....	30

LIST OF TABLES

Table 1 Trip Generation Assumptions.....	6
Table 2 Performance Measure Summary for Freestanding Community	19
Table 3 Total Travel Time – 65 mph IRC Corridor.....	20
Table 4 Supporting Model Output for Freestanding Community Scenarios	21
Table 5 Performance Measure Summary for Ten-Mile Commuter Corridor	22
Table 6 Supporting Model Output for Ten- Mile Commuter Corridor.....	23
Table 7 Performance Measure Summary for Disconnected Backage System.....	27
Table 8 Posted Speed Sensitivity Analysis – Freestanding Community	31

INTRODUCTION

Transportation is one of the key components in maintaining a prosperous economy and a high quality of life. Over the last 20 years, the U.S. economy has become more diversified and global, and the ability to efficiently ship and receive goods and materials has become more important. At the same time, substantial growth has occurred in and around the Twin Cities Metropolitan area, in major regional centers, and in rural lakes areas. This growth has placed more demands on the transportation system.

To address these concerns, the Minnesota Department of Transportation's (Mn/DOT) has focused many of its resources toward high-level transportation facilities, typically principal arterials and/or minor arterial routes. These routes typically carry high volume, high-speed traffic and therefore are managed to achieve higher levels of mobility. The Department's efforts to address mobility problems have been the emphasized in policy and investment decisions, including the following:

- The ***Mn/DOT Business Plan*** promotes safety, investment in transportation infrastructure, protection of past investments, and providing reasonable access and mobility for the movement of people and goods.
- The development of Minnesota's Interregional Corridor System (IRC) and policies that support this system focus on the need to protect the mobility of IRC corridors. ***Interregional Corridor Policy 5*** was one of the key policies that encourage local system planning and cooperation between multiple agencies so that local and regional needs could both be achieved. The policy in part says "...corridors should perform at or above targeted levels with minimal interruption to traffic flow".
- **Mn/DOT's Draft 2003 State Transportation Plan** identifies performance measures and targets to minimize the degradation or loss of performance on the Interregional Corridor System.

While these policies focus on maintaining and/or improving mobility, Mn/DOT also recognizes that its customers are users of the entire roadway network (i.e., there are very few trips that begin and end entirely within its system). Therefore, to serve the intended users, transportation officials must seek to balance the need for mobility with the demands for access. The balancing of these different needs varies depending upon the function of the roadway in the overall network. The purpose of this study was to provide additional information for assessing the optimal balance between access and mobility, in terms of full movement intersection spacing, on principal arterials through urban areas (i.e., generally higher volume, higher speed roadways on the trunk highway system).

STUDY APPROACH

The approach used for the study was to develop a small-area traffic model that could assess operational differences for one-quarter mile, one-half mile, and one-mile signalized intersection spacing alternatives. The operational differences would be analyzed from the perspective of the impacts to mainline flow (travel times), as well as, the impacts to the entire transportation network or system.

Two theoretical corridor settings were used to test the impacts of these different signal spacing alternatives. The first corridor setting is shown in Figure 1 and represents a three-mile small-to medium-size freestanding urban center (two-mile urbanized area with signals at the identified spacing and a one-half mile of undeveloped area on either end for a total of three-miles). The second setting is intended to represent a ten-mile commuter corridor through a developing suburban area (Figure 2). Both of these corridors are set in the context of a 65-mile corridor so that the impacts of the various signal spacing could be compared against the IRC performance goals that have been established for interregional corridor routes.

Land Use and Trip Generation Methodology

One of the initial steps in this study was to identify a land use scenario that would provide a basis for comparing different signalized intersection spacing. The land uses that were assumed include a mix of retail, office, business, service-commercial, and industrial. These uses were distributed over eight internal zones; each zone represents approximately 40 acres of development (360 total acres or an area quarter mile wide by two miles long). Two of these zones were assumed to have primarily retail/business commercial land uses, four zones were assumed with primarily employment based land uses (office/business land uses) and two of these zones were assumed to have industrial park type land uses (Figure 3).

In addition, 16 external zones were assumed to represent traffic entering and/or exiting the study area to other land uses beyond the model limits. The cross-street external zone traffic was assumed to be characteristic of smaller urban areas and freestanding growth centers along rural or suburban major highways. One of these cross-streets was assumed to be an arterial level facility and was located in the center of the study area. A nine percent peak hour and a 60/40 directional split were assumed for the mainline and cross-street traffic volumes.

A traffic assignment network and peak hour trip table for eight internal and 16 external zones was developed. Daily and peak hour trip generation estimates (Table 1) were based on the appropriate average trip generation rates from the 1997 Institute of Transportation Engineers "Trip Generation" report. The study area land use and trip generation assumptions are characteristic of smaller urban areas and freestanding growth centers along rural or suburban major highways in Minnesota (i.e., Buffalo, St. Peter and Hutchinson).

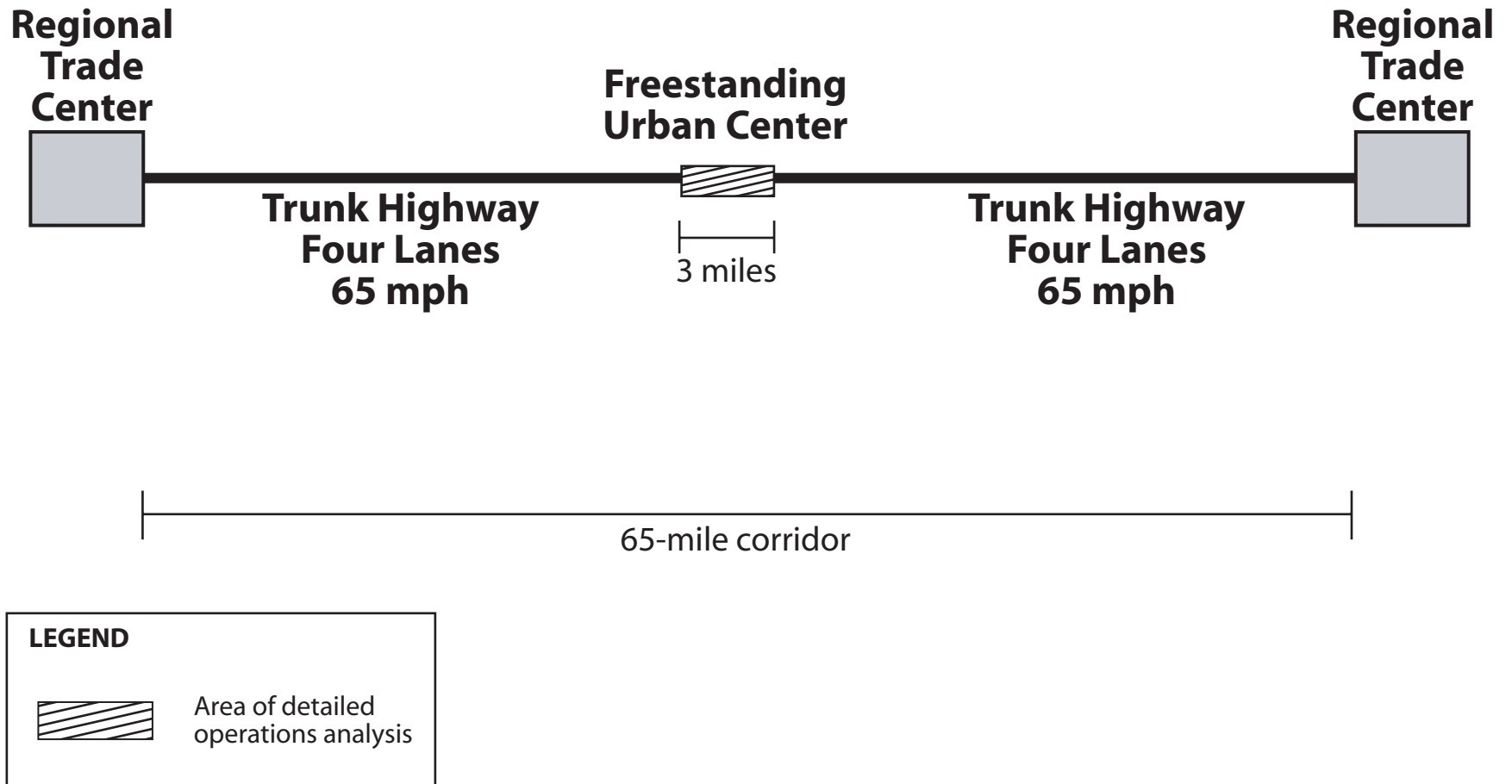

**Regional
Trade
Center**



**Trunk Highway
Four Lanes
65 mph**

**Study
Area**



10 miles

**Metropolitan
Area**

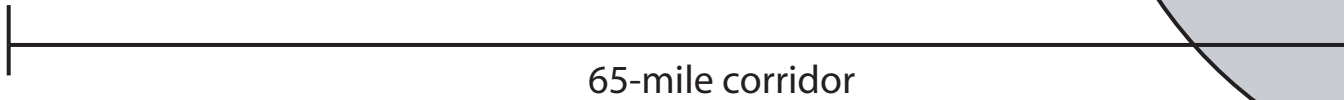
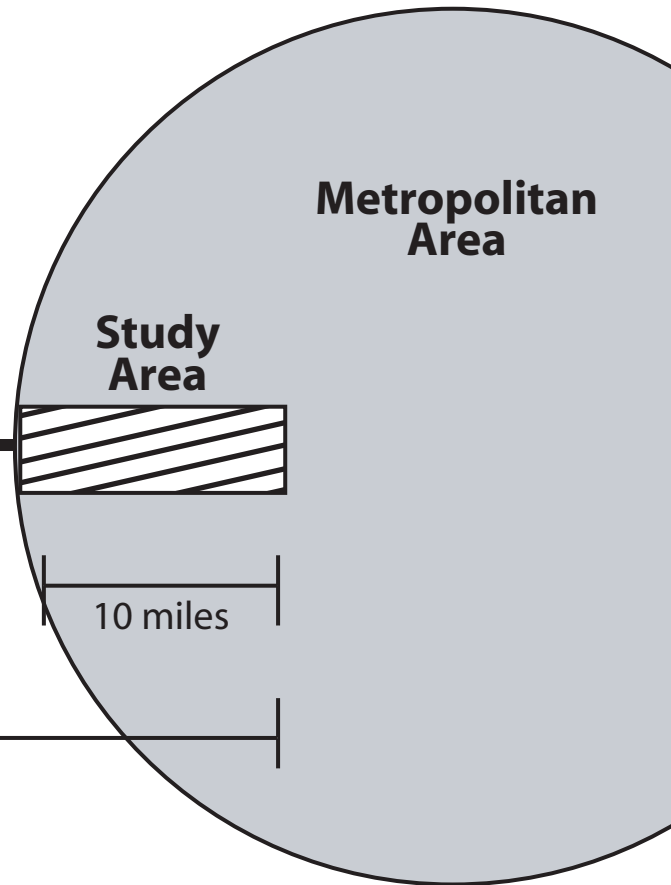

65-mile corridor

LEGEND



Area of detailed
operations analysis



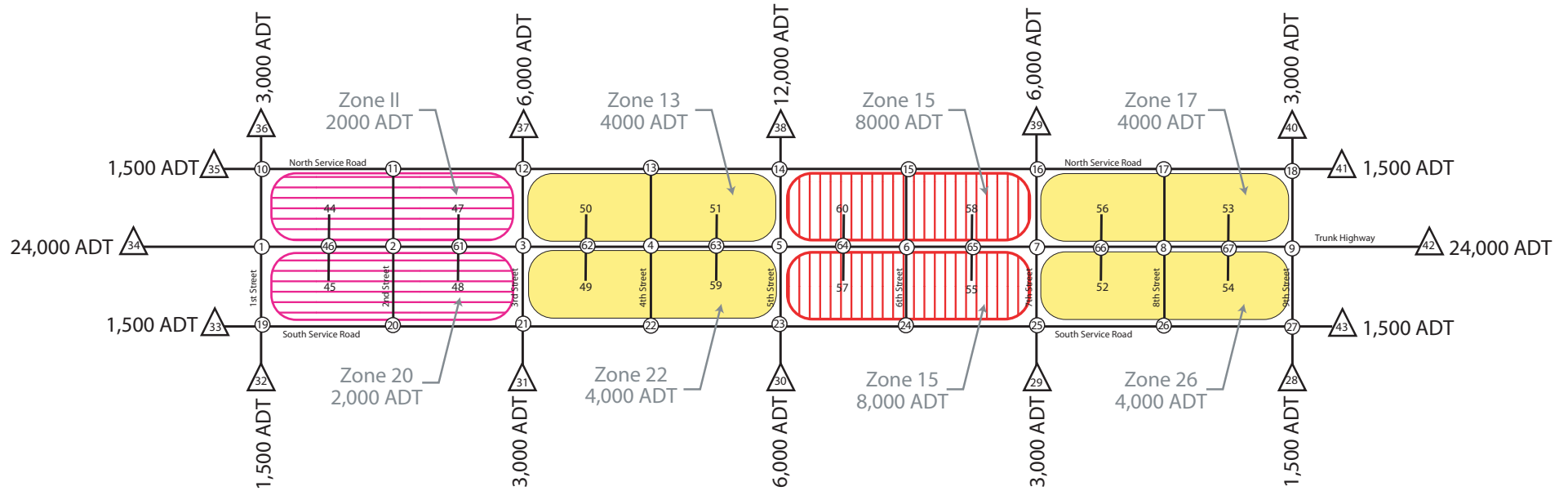

LEGEND

	Industrial Park		External Nodes
	Office/Business Commercial		Intersections
	Retail/Business Commercial		



- NOTE:**
- (1) Volumes shown at external nodes are two-way link volumes
 - (2) Volumes shown for zones are number of daily trips generated by land use assumptions

Table 1
Trip Generation Assumptions

Internal Zone Lane Use Type	Units	Daily	P.M. Peak Hour	
		Total Trips	Trips In	Trips Out
Zone 11 - Industrial Park	40 acres	2,000	40	160
Zone 13 - Office/Business Commercial	40 acres	4,000	140	260
Zone 15 - Retail/Business Commercial	40 acres	8,000	400	400
Zone 17 - Office/Business Commercial	40 acres	4,000	140	260
Zone 20 - Industrial Park	40 acres	2,000	40	160
Zone 22 - Office/Business Commercial	40 acres	4,000	140	260
Zone 24 - Retail/Business Commercial	40 acres	8,000	400	400
Zone 26 - Office/Business Commercial	40 acres	4,000	140	260
Totals	320 acres	36,000	1,440	2,160

Source: Institute of Transportation Engineers, *Trip Generation*, 6th Edition, 1997.



Network Assumptions

Three different roadway system/access spacing networks were developed for the freestanding community scenario. The alternative roadway networks included options for signalized intersections at quarter-mile, half-mile and one-mile spacing with uncontrolled right-in/right-out intersections located at midpoint intersections (Figures 4, 5 and 6). Each of the alternatives included parallel service roads which were located approximately 750-feet each side of the four lane principal arterial. All mainline intersections were assumed to have standard length left and right turn lanes (300-foot storage areas and 180-foot tapers). Side street approaches were all assumed to be two lane roadways with left and right turn lanes at the mainline intersections. The posted speed assumed for the mainline facility was 45-mph for the one-quarter mile signal spacing and 65-mph for the one-half and one mile signal spacing. All local streets were assumed to have posted speeds of 30-mph.

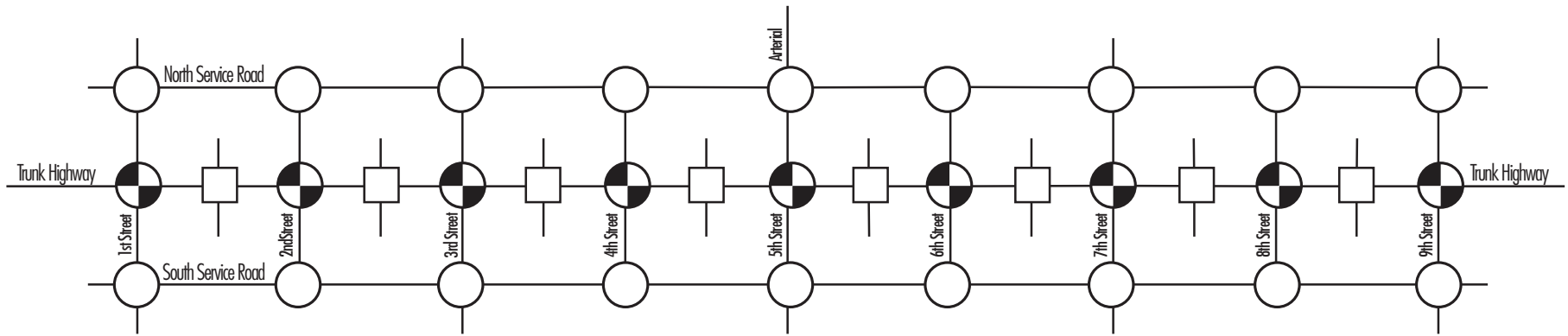
The 10-mile commuter corridor network was created by copying the center two-mile signalized portion of the three-mile network and replicating it five times to achieve the ten-mile corridor. All of the network-assumptions used in the three-mile corridor were replicated for the 10-mile corridor with the exception of the 45-mph posted speed and the external volumes for the mainline. A 45-mph speed alternative was not assumed because a quarter-mile signal spacing scenario was not analyzed for the commuter corridor scenario (65-mph assumed). The mainline volumes for the 10-mile commuter corridor began at 24,000 vehicles-per-day on one end and increased to 36,000 vehicles-per-day on the other.



LEGEND



-  Signalized Intersection
-  Right-In, Right-Out Intersection
-  Non-Signalized Intersection

Speed Assumptions

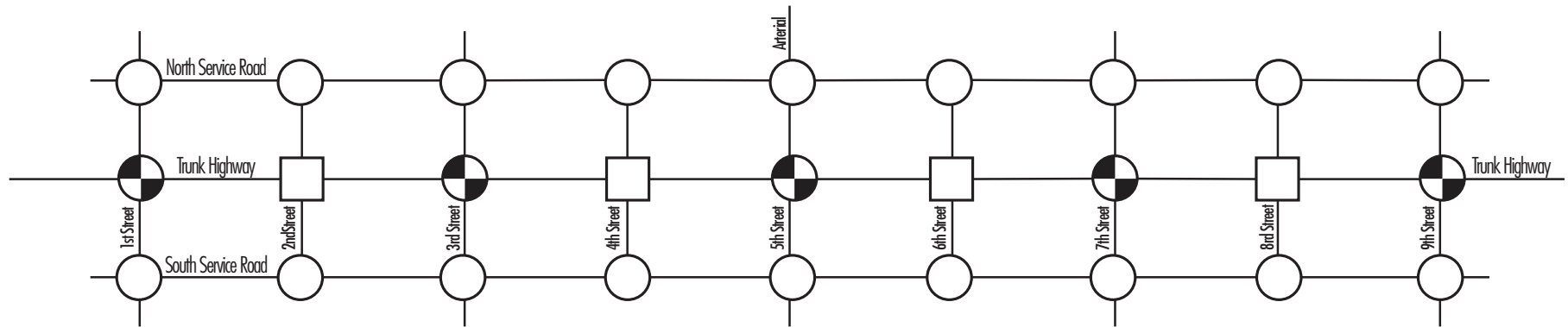
- (1) All cross-street and service road speeds are 30 mph.
- (2) The trunk highway speed is 45 mph.



LEGEND



-  Signalized Intersection
-  Right-In, Right-Out Intersection
-  Non-Signalized Intersection

Speed Assumptions

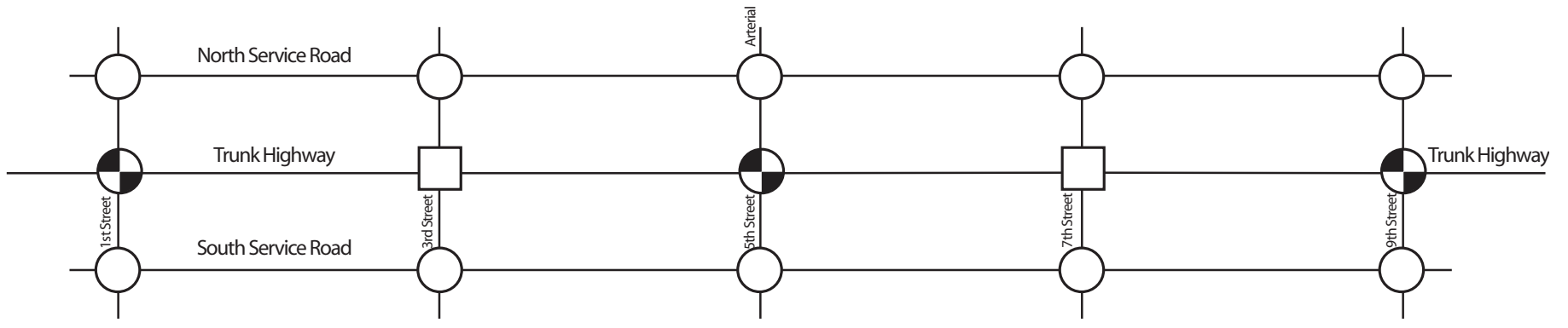
- (1) All cross-street and service road speeds are 30 mph.
- (2) The trunk highway speed is 65 mph.



LEGEND

-  Signalized Intersection
-  Right-In, Right-Out Intersection
-  Non-Signalized Intersection

Speed Assumptions

- (1) All cross-street and service road speeds are 30 mph.
- (2) The trunk highway speed is 65 mph.

Network Assignment

The directional trip distribution for traffic generated within the study area and the externally generated traffic was developed based on a gravity model. This gravity model calculates the relative number of trips made between traffic assignment zones (TAZs). This calculation is based on the following:

The relative number of trips between TAZs is directly proportional to the trip ends (productions or outbound trips and attractions or inbound trips) for each TAZ and inversely proportional to the travel time between TAZs.

The traffic generated within the study area and the assumed external background traffic was assigned to the study area roadway network using a computer traffic assignment model (CARS). This is a dynamic multi-path travel time and delay based computer model that assigns traffic between study area origins and destinations based on the shortest travel time routes. Traffic forecasts were developed for each of the three signal spacing alternatives using this model. Figure 7 shows the distribution of these trips in the study area as identified by the cordon of the study area (percentages reflect all of the trips in the study area). For the purposes of this study, the terms were defined:

- *Through-Through Trip:* This is a mainline trip that enters the study area on one end, and continues on the mainline through the entire study area exiting the study area at the opposite end of the corridor. These trips are a subset of the external to external trips described below.
- *External to External Trip:* This is a trip that enters the study area through one of the sixteen external stations and continues through the study area exiting at one of remaining fifteen external stations. This trip may travel on a number of different routes to get to the exit point. An example is a trip from an adjacent neighborhood outside the study area passing through the study area to a neighboring town or another neighborhood outside the study area.
- *External to Internal Trip:* This trip is destined from a point outside the study area to a location within the study area. An example would be a trip from a neighborhood outside the study area to a store or office within the study area.
- *Internal to External Trip:* Same as the external to internal trip identified above with the exception that the order is reversed (e.g., trip from the store or office in the study area to home, neighborhood or other destination outside of the study area).
- *Internal Trip:* This trip is made entirely within the study area. For example, it could be an auto parts store running a part to a nearby garage, or it could be local shopping trips.

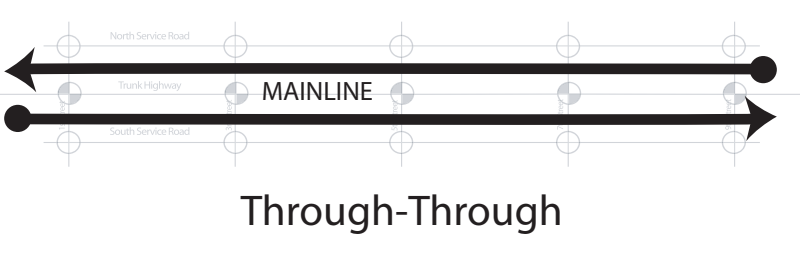
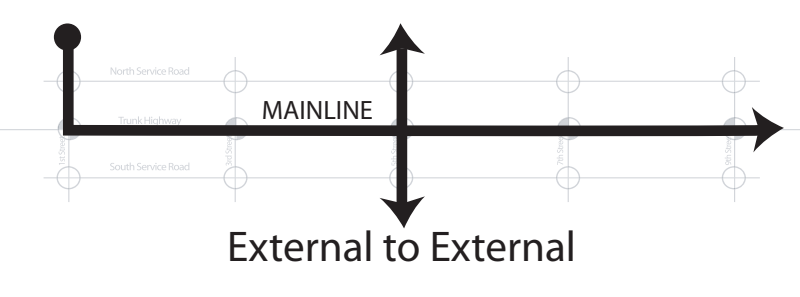
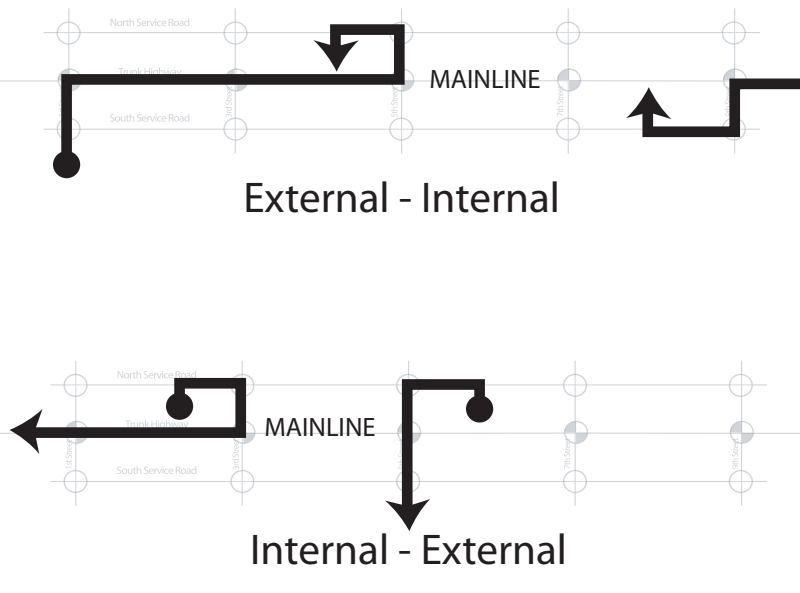
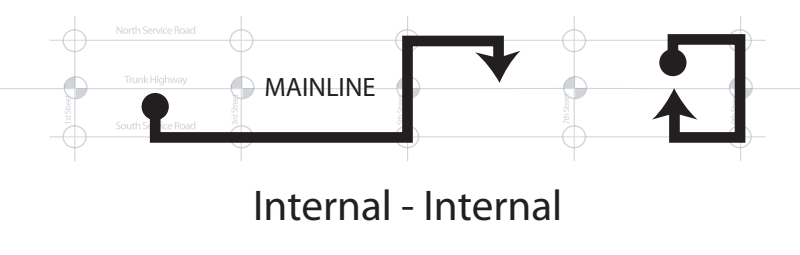
<p>External - External</p>	 <p>Through-Through</p>	<p>Through-through trips are a subset of external-to-external trips described below. The percentage of the mainline volume that are through-through trips is 21 percent for the free-standing community.</p>
<p>External - External</p>	 <p>External to External</p>	<p>These trips are traveling through the study area, entering from an external station and leaving at another external station. Their type of trip may use all, a portion, or be entirely off of mainline.</p>
<p>External - Internal Internal - External</p>	 <p>External - Internal Internal - External</p>	<p>External-internal or internal-external trips comprise 46 percent of the trips made in the free-standing community scenario and 52 percent of the trips made in 10-mile commuter corridor scenario. This type of trip is a relatively high percentage due to the narrow limits of the study area.</p>
<p>Internal</p>	 <p>Internal - Internal</p>	<p>Internal to internal trips within the limits of the model area. Internal trips comprise 7 percent of all trips in free-standing community scenario and 19 percent of trips in 10-mile commuter scenario.</p>

Network Forecasts

Peak hour traffic forecasts for each alternative were developed based on the traffic assignment model. The volume and land use assumptions were held constant for each of these alternatives (volume at both a cordon and screen line level is the same). These forecasts are shown in Figures 8, 9 and 10 for the three-mile scenario.

Traffic Operations Analysis Methodology

Two computer traffic operations models (Synchro and SimTraffic) were used to analyze and evaluate the operation of the corridor and system for the different alternatives. Synchro is a traffic operations model that analyzes intersection and arterial operations and optimizes traffic signal timing based on traffic volume, speed, geometric conditions, delay, queuing and stops. SimTraffic (an FHWA Corsim-based simulation model) is a microscopic traffic simulation model that provides a more detailed simulation analysis and evaluation of the traffic operations and measures of effectiveness for the study area network. This model was used to determine the through-through speeds (average speed of mainline through vehicles that go through the entire study area on the mainline).

Traffic signal timing parameters (cycle length, minimum mainline through green times and minimum mainline through bandwidths) were developed assuming the Mn/DOT Signal Spacing and Recommended Signal Timing Guidelines¹. Based on these parameters, the minimum through green on the mainline approaches was fixed to comply with the recommended minimums. Then the model was allowed to optimize based on the following:

- The Synchro traffic operations model optimizes (in order of priority) the signal cycle lengths, phase splits, offsets and lead/lag order. The cycle length optimization evaluates a user-defined range of cycle lengths and selects the cycle length that provides the best performance based on various Measures of Effectiveness (MOE) and a Performance Index (PI). The cycle length optimization will choose the cycle length with the lowest performance index. The PI is calculated based on the total or network wide (signal delay *1 + total vehicle stops *10 + total queuing penalty *100). The sum of these factors is then divided by 3,600.
- The Synchro model will test all cycle lengths in the range to determine the shortest cycle length that clears the traffic for each phase. In general, shorter cycle lengths have shorter uniform delay and shorter queues and will be favored when comparing delays of various cycle lengths. In some cases a longer cycle length may give lower delays or other benefits, particularly at intersections over-capacity or on high-speed/high-volume facilities. Some specific tests were made for longer cycle lengths; however, these tests did not show any significant advantages over the optimized cycle lengths and therefore the optimized cycle lengths were used and are reflected in the reported results.

¹ These guidelines have since been discontinued; however, they reflect the assumptions and the process that was used to develop the results.

Figure 8 (11 x 17 figure, see separate folder)
Design Hour Volumes: Quarter-Mile Signal Spacing (disconnected service roads)

Figure 9 (11 x 17 figure, see separate folder)
Design Hour Volumes: Half-Mile Signal Spacing

Figure 10 (11 x 17 figure, see separate folder)
Design Hour Volumes: One-Mile Signal Spacing

- Phase splits are optimized based on the lane group volume divided by the adjusted saturation flow rate. Intersection offsets and lead/lag order are optimized based on the lowest delay.

The methodologies and assumptions outlined above reflect standard traffic engineering practices for developing and analyzing a small traffic network. The average through-through travel time for the each alternative was then determined and these times were then used to help calculate the travel time and speed for a 65-mile trip. For this calculation, it was assumed that the average travel speeds outside of the three-mile and ten-mile analysis areas were free flowing at a speed of 65-mph.

PERFORMANCE MEASURES

The traffic models have numerous outputs or measures that can be used for comparison purposes. Since one of the goals of the study was to assess the operational differences with respect to mainline flow and how these impacts relate to the overall IRC performance measures, mainline travel time was one of the measures selected for evaluation. The other main evaluation measure was selected to assess the impact of the different alternatives on overall system performance. Overall system performance is a function of how efficient the system is in accommodating all trips (i.e., travel time, vehicle-miles, and stops). As a result, the second measure focused on overall user costs. To obtain this measure, the results from these different performance measures were pulled from the model output including Vehicle-Hours Traveled (VHT), Vehicle-Miles-Traveled (VMT) and number of stops. These components were then combined using benefit-cost methodologies to obtain an overall economic measure for a peak hour time period. A more detailed summary of the performance measures are outlined below.

1. Travel Time Measure

Total mainline travel time is the time it would take for users to make the entire 65-mile trip from one end of the larger corridor to the other (see figures 1 and 2). This measure was used to assess the impact of different signal spacing alternatives on longer trips given the goal of maintaining performance on the Interregional Corridor system. These times were then converted to travel speed and compared to the IRC performance targets.

The computation of the overall travel time is based on the assumption that areas outside of the detailed modeled area flow at a free-flow speed of 65-mph. Measurement of travel times within the modeled study area (three-miles for the freestanding urban center and ten-miles for the commuter corridor) focused on vehicles that travel through the entire network on the mainline (through-through vehicles). The average travel times of through-through vehicles were computed by capturing and documenting the time (in the model) that through-through vehicles entered the study area and time that they left the study area on the other end of the network. Travel times were logged for numerous vehicles and averages computed. The average times were then used to develop an overall travel time for the entire 65-mile trip. The overall travel times for the corridor were then compared to the different IRC guidelines for High-Priority and Medium Priority IRCs and Regional Corridors.

Average Through-Through Speeds have been reported in various tables for comparison purposes and they show the direct result of travel time impacts (in terms of average speeds) to mainline through-through vehicles within the modeled area.

2. User Cost

Overall system user costs were computed for the one-quarter-mile, one-half mile and one-mile signal spacing alternatives for the freestanding commuter corridor. These user costs represent the full-range of trips in the model (see Figure 7). The computation of user costs used a number of different outputs from the operations model. The following summarizes these output measures and the methodology that was used to compute the user cost.

- *Vehicle Miles of Travel (VMT)* – A vehicle mile represents one vehicle traveling for one mile or some number of vehicles traveling for portions of a mile that add up to one mile of total travel. This measure was used to assess the operational costs of alternatives (amount of travel on the system or network as compared to a base system).
- *Vehicle Hours of Travel (VHT)* – A vehicle hour represents one vehicle traveling for one hour or some number of vehicles traveling for portions of hours that add up to one hour of total time. This measure is used to assess the amount of time spent traveling on a facility or network. Alternatives that provide lower VHT are generally considered more efficient.
- *Total Stops* – These are the stops on all approaches to intersections within the network in the computer model. The total stops were used to help calculate an operational cost component for the entire system. This analysis factored in the different assumptions for vehicle speeds in the network.
- *Through Stops* – These are the signal-induced stops that affect the mainline through vehicles. This measure was used to help calculate the operational component of the user cost (stops on higher speed routes result in higher user costs than stops on lower speed routes).
- *User Cost Analysis* – This analysis was used to bring a number of different measures into a common measure, dollars. This analysis was done for comparison purposes to estimate user costs for the different signal spacing alternatives. User costs were calculated based on the model output and the following assumptions and/or methodology.
 1. Values of VMT, VHT, and the number of stops were pulled from the model for each of the signal spacing alternatives. Unit costs were then applied to these values to convert the measures to costs. The costs reflected are on a peak hour basis.
 2. Six percent of the mainline traffic stream was assumed to be trucks during the peak hour analysis. Vehicle occupancy was assumed to be 1.2.
 3. The unit costs were based on Mn/DOT’s Office of Investment Management (OIM) guidelines updated in June of 2002. Based on this guideline, the unit costs that were used for this analysis were as follows:
 - Cost per hour (auto driver) \$ 9.92 per hour
 - Cost per hour (trucks)..... \$ 18.40 per hour
 - Cost per mile (auto)..... \$ 0.28 per mile
 - Cost per mile (trucks)..... \$ 1.43 per mile
 4. Operational costs were calculated for both miles traveled (operational cost to operate a vehicle for each mile driven in the network) and for stops (extra cost for vehicles braking and then accelerating after stopping). The unit cost per mile used for this analysis is based on unit costs identified above. Additional costs were calculated for each mainline stop and for each non-mainline stop. These were calculated separately because the costs are different due to the difference in posted speeds. The unit cost per 1,000 mainline stops was assumed to be \$124.56 and the cost per 1,000 non-mainline stops was assumed to be \$48.34. These costs were based on information from the Table A-3 from the United States Department of Transportation’s “Procedure for Estimating Highway User Costs, Fuel Consumption and Air Pollution” (March 1980).

ANALYSIS RESULTS

The results of the traffic operations analyses have been separated into three major areas: results for the three-mile Freestanding Community; results for the 10-mile Commuter Corridor; and discussion/results from “what if analysis”.

Freestanding Community

The Freestanding Community scenario represents a major four-lane highway corridor going through a medium sized community. The analysis was done holding the number of trips and land use constant and varying the supporting transportation network (signal spacing) from one-quarter mile, to one-half mile, to one mile. The results were tabulated for the two performance measures and are shown in Table 2.

1. Travel Time – IRC Performance Targets

The results show that overall travel time for the 65-mile corridor increases as the signal spacing decreases (more signals are added in the urban center). However, the difference in travel time and mainline speed are relatively minor for the one-half mile and one-mile spacing alternatives. Adding the first three signals to the corridor (1-mile spacing alternative) adds 1.3 minutes of travel time to the overall 65-mile trip as compared to the same length trip on a corridor without any signals. Adding the second two signals (for a total of five signals, one-half mile spacing scenario), adds 1.8 minutes to the total trip or 30 seconds more than the one-mile spacing.

Table 2
Performance Measure Summary for Freestanding Community

Evaluation Measure	Signal Spacing for Three-Mile Network ^{(1), (2)}		
	1/4-Mile	1/2-Mile	1-Mile
Mainline Travel Time ⁽³⁾ (min)	62.7	61.8	61.3
Average Mainline Speed ⁽³⁾ (mph)	62.2	63.1	63.6
User Cost ⁽⁴⁾ (dollars)	\$5,527	\$5,538	\$7,026

Notes:

- (1) Assumes a full frontage road network.
- (2) A three-mile segment of a four-lane divided arterial – representing a small urban area. Assumes 45 mph mainline posted speed for quarter-mile signal spacing and 65 mph mainline posted speed for half-mile and one-mile signal spacing.
- (3) Mainline travel time for 65-mile corridor with one freestanding urban center.
- (4) User cost for peak hour of the day.

Signals spaced at a quarter-mile add a total of 2.7 minutes to the overall 65-mile trip, which is approximately one minute more than the half-mile signal spacing and 1.5 minutes more than the one-mile signal spacing. These travel time results compare favorably with the results from actual travel time runs on IRC corridors².

Based on these results of a single freestanding community, all of the signal spacing alternatives would meet the High-Priority, Medium Priority and Regional IRC performance goals. However, if the number of freestanding communities increased in the corridor, the ability to meet these goals may be impacted. Table 3 shows the impact to travel times and speeds as the number of freestanding communities changes.

Table 3
Total Travel Time and Speed – 65 mile IRC Corridor ^{(1) (2)}

Signal Spacing	Number of Freestanding Communities		
	Two	Three	Four
Quarter-mile Spacing	65.4 / (59.6)	68.1 / (57.2)	70.8 / (55.1)
Half-mile Spacing	63.6 / (61.3)	65.4 / (59.6)	67.2 / (58)
One-mile Spacing	62.6 / (62.3)	63.9 / (61)	65.2 / (59.8)

Notes:

⁽¹⁾ XX = Travel time in minutes followed by / (XX) = Average speed in mph

⁽²⁾ The performance results assume that all links operate without capacity problems.

The results show that all signal spacing alternatives meet the Medium-Priority IRC (55-mph) and Regional Corridor (50-mph) performance guidelines. However, the High-Priority (60-mph) performance guidelines were met for only the options that are shaded.

2. Overall System User Costs

The freestanding community scenario was also evaluated in terms of user costs (see Table 2). This evaluation focused on overall network efficiency, not just mainline operations. The comparison shows that one-quarter mile and one-half mile signal spacing alternatives result in similar user costs; however, the one-mile spacing results much greater costs (\$1,500 or approximately a 30 percent increase over the one-quarter mile alternative). Increased circuitry to and from local destinations and increased delay at intersections resulted in greater VHT and user costs. The detailed output for computing the user costs are shown in Table 4.

² Re-evaluation of IRC Speed Prediction Methodology, Mn/DOT Office of Investment Management July 2001.

Table 4
Supporting Model Output for Freestanding Community Scenario

Mainline Output ⁽³⁾	Signal Spacing for Three-Mile Network ^{(1), (2)}		
	1/4-Mile	1/2-Mile	1-Mile
Through-Through Speed (mph)	34.4	41.6	46.7
Through-Through Travel Time (min)	5.2	4.4	3.9
Mainline Stops (veh)	4,237	4,119	3,113
Network/System Output ⁽³⁾			
Vehicle-Miles Traveled (VMT)	6,134	6,309	6,758
Vehicle-Hours Traveled (VHT)	244	237	339
Total Stops (veh)	8,093	8,819	10,503

Notes:

- (1) Assumes a full frontage road network.
- (2) A three-mile segment of a four-lane divided arterial – representing a small urban area. Assumes 45 mph mainline posted speed for quarter-mile signal spacing and 65 mph mainline posted speed for half-mile and one-mile signal spacing.
- (3) Numbers are for peak-hour. Assumes optimized cycle lengths.

Some of the reasons the one-mile signal spacing does not fair better in this analysis include:

- (1) Through traffic signal progression and green bandwidth was easier to achieve on half-mile spacing than on the one-mile spacing. This is due to:
 - Platoon dispersion
 - Concentration of mainline lefts at fewer intersections
 - Concentration of side street volumes
 - Queue clearance from upstream intersection movements.
- (2) Further limiting the number of intersections from one-half mile to one-mile results in greater numbers of turning and cross-street vehicles at the remaining intersections. The increased volume of these movements generally requires additional green time thus limiting the green time one can devote to the mainline through vehicles.
- (3) Vehicles arriving on either end of the community are assumed to arrive at random. Typically, 60 percent of green bandwidth assigned to mainline and 40 percent for other movements. As a result, 40 percent of mainline vehicles are stopped at the first signal in the system under any alternative. Once the vehicle, is in the platoon delay at downstream signals should be minimal.

Ten-Mile Commuter Corridor

The Ten-mile Commuter Corridor scenario represents a major four-lane highway corridor going into a large metropolitan area. The last ten miles of the 65-mile corridor are within a developing suburban area. The analysis was done holding the number of trips and land use constant and varying the transportation network to test one-half mile and one-mile signal spacing. The results of the evaluation are shown in Table 5.

Table 5
Performance Measure Summary for Ten-Mile Commuter Corridor

Evaluation Measure	Signal Spacing Ten-Mile Commuter Corridor ^{(1), (2)}	
	1/2-Mile	1-Mile
Mainline Travel Time ⁽³⁾ (min)	63.2	62.4
Average Mainline Speed ⁽³⁾ (mph)	61.7	62.5
User Cost ⁽⁴⁾ (dollars)	\$23,400	\$29,700

Notes:

- (1) Assumes a full frontage road network.
- (2) A ten-mile segment of a four-lane divided arterial - representing an area entering a large metropolitan area. Assumes 65 mph mainline posted speed for half-mile and one-mile signal spacing.
- (3) Mainline travel time and speed for 65-mile corridor with ten-miles of suburban development.
- (4) User costs are for the peak hour of the day.

1. Travel Time – IRC Performance

If signals are spaced at every half-mile over the ten-mile commuter corridor, approximately 3.2 minutes is added to a 60-minute, 65-mile trip, assuming the remaining portion of the corridor operates at a free-flow condition. This is approximately one minute more than the travel time for the one-mile signal spacing alternative. This time difference is a relatively insignificant amount for an hour-long trip.

Based on these travel times, both of these alternatives meet the High-Priority IRC performance guidelines (60-mph). They also meet the performance guidelines for Median Priority ITCs (55 mph) and High-Priority Regional Corridors (50 mph).

2. Overall System User Costs

The Ten-mile Commuter Corridor scenario was also evaluated in terms of user costs. This evaluation focused on overall network efficiency, not just mainline operations. The comparison shows that one-half mile signal spacing alternatives resulted in lower overall user costs during the peak hour (\$6,300 over the one-mile alternative). The majority of these increased costs are a direct result of a 43 percent increase in VHT. This large increase is a consequence of greater circuitry of travel to and from local destinations and increased overall delay at the intersections. The detailed model results that were used to calculate user costs are shown in Table 6.

Table 6
Supporting Model Output for Ten-Mile Commuter Corridor Scenario

Mainline ⁽³⁾	Signal Spacing Ten-Mile Network ^{(1), (2)}	
	1/2-Mile	1-Mile
Through-Through Speed (mph)	48.8	52.7
Through-Through Travel Time (min)	12.29	11.38
Mainline Stops (veh)	10,622	8,028
Network/System ⁽³⁾		
Vehicle-Miles Traveled (VMT)	26,633	28,560
Vehicle-Hours Traveled (VHT)	1,002	1,433
Total Stops (veh)	38,141	45,424

Notes:

- (1) Assumes a full service road network.
- (2) A ten-mile segment of a four-lane divided arterial - representing suburban fringe area.
- (3) Numbers are for peak hour. Assumes optimized cycle lengths.

What If Analysis



There were a number of issues that arose over the length of the study that prompted additional analysis, investigation and/or extrapolation of results. Some of these issues involved identifying the potential effects of system changes such as increased volumes, changes in network assumptions, and changes in land use. In some cases, the authors have speculated on the impacts of these changes based on their professional experience and knowledge. These issues are outlined below:

- 1. The initial analysis assumed a continuous backage road system on each side of the mainline. In Minnesota there are many physical constraints, so most communities have difficulty in developing a continuous parallel frontage or backage road system. What is the impact on mainline operations if a continuous frontage or backage roadway is not assumed?**

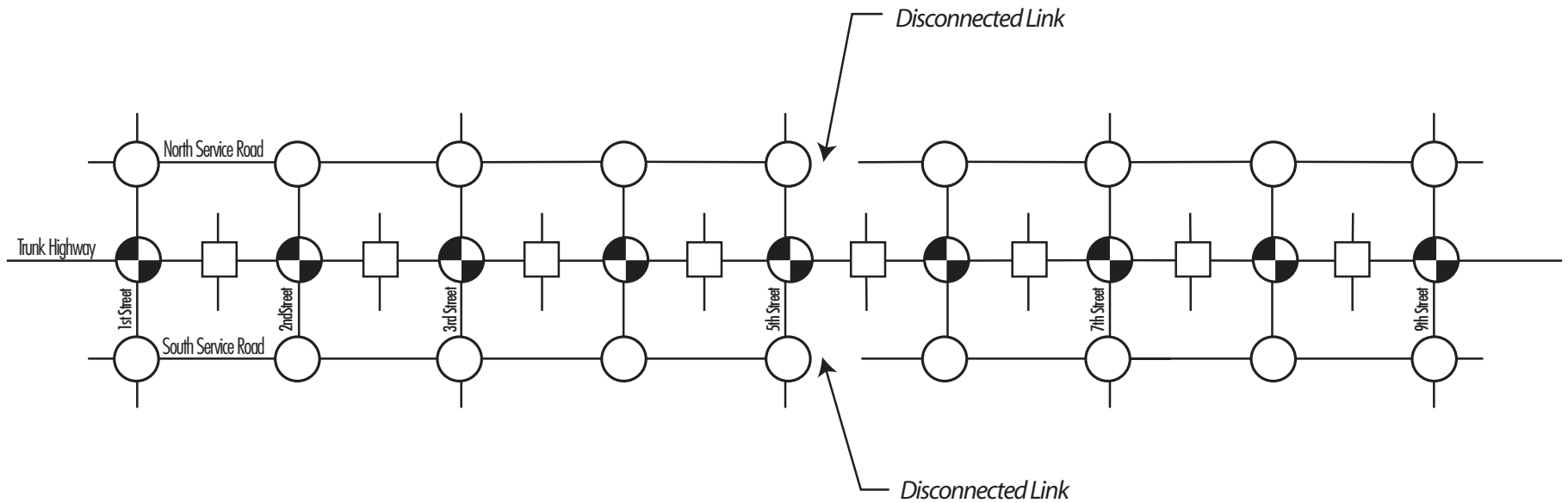
Disconnecting the backage roads was tested for the Freestanding Community scenario. This was done by severing one of the links on either side of the mainline (Figures 11, 12, and 13). The link severed was near the center of the community. The traffic assignment and operations models were then rerun to assess the impacts of this change. The results are shown in Table 7 and described below.



LEGEND

-  Signalized Intersection
-  Right-In, Right-Out Intersection
-  Non-Signalized Intersection



Speed Assumptions

- (1) All cross-street and service road speeds are 30 mph.
- (2) The trunk highway speed is 45 mph.

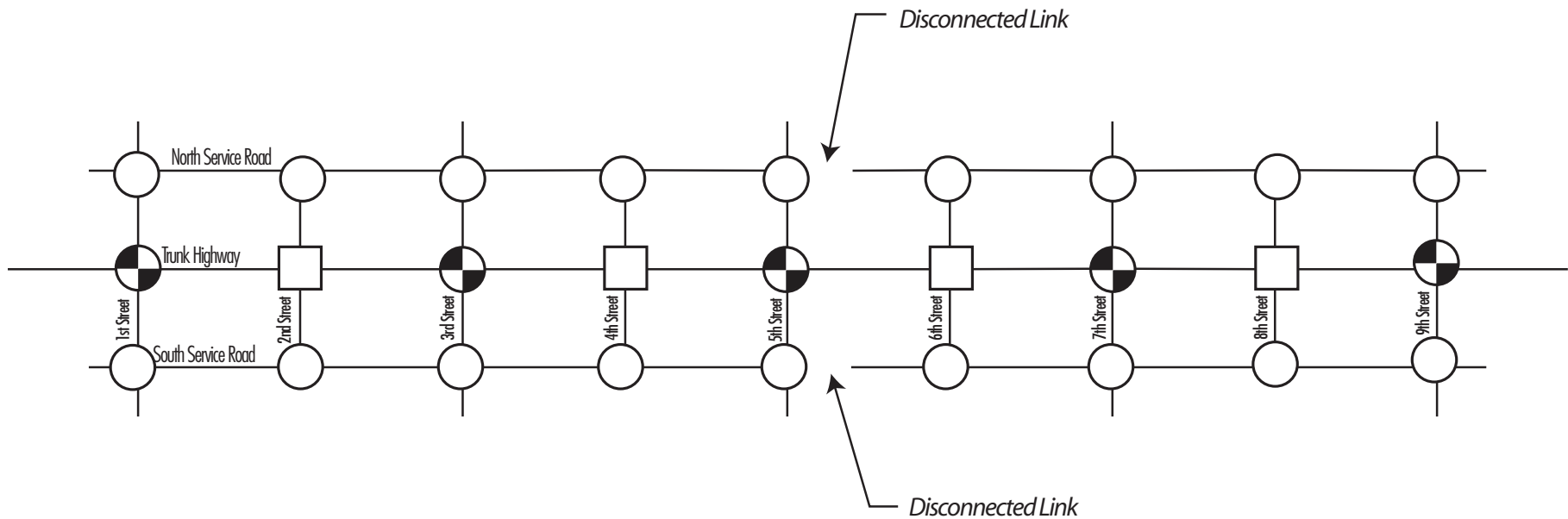
This model network is the same as the Quarter-Mile Spacing Scenario, except for the disconnected service road link as noted.



LEGEND

-  Signalized Intersection
-  Right-In, Right-Out Intersection
-  Non-Signalized Intersection



Speed Assumptions

- (1) All cross-street and service road speeds are 30 mph.
- (2) The trunk highway speed is 65 mph.

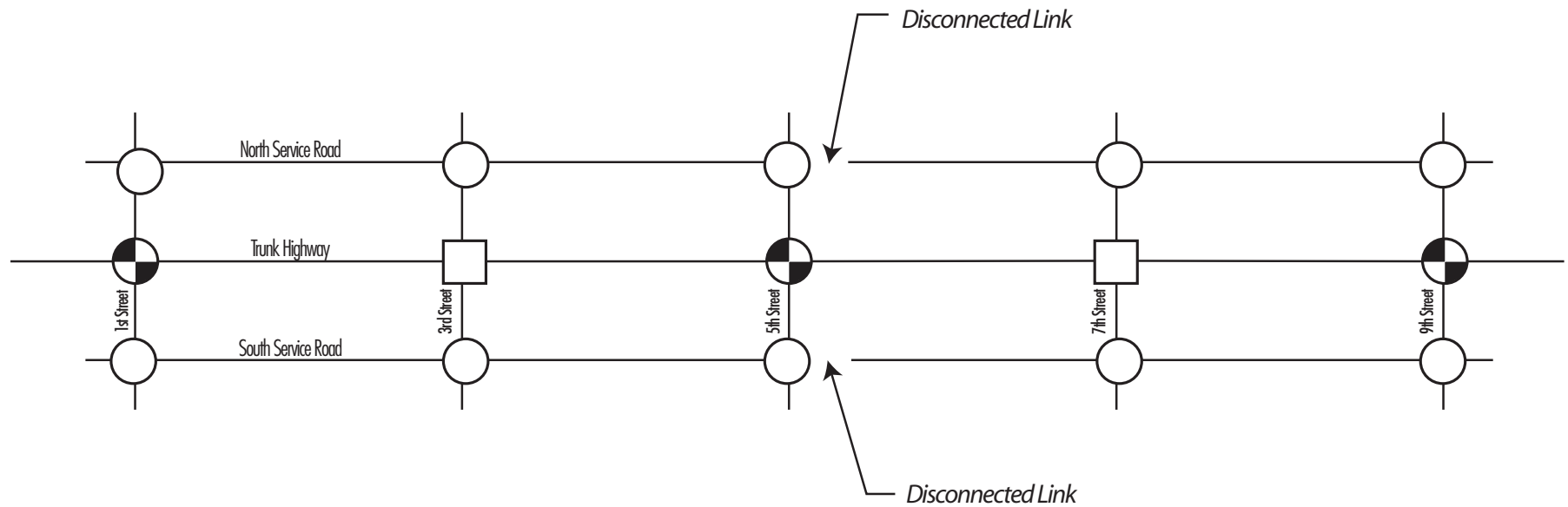
This model network is the same as the Half-Mile Spacing Scenario, except for the disconnected service road link as noted.



LEGEND

-  Signalized Intersection
-  Right-In, Right-Out Intersection
-  Non-Signalized Intersection

Speed Assumptions

- (1) All cross-street and service road speeds are 30 mph.
- (2) The trunk highway speed is 65 mph.

This model network is the same as the One-Mile Spacing Scenario, except for the disconnected service road link as noted.

Table 7
Performance Measure Summary for Disconnected Backage System

Evaluation Measure	Signal Spacing for Three-Mile Network ^{(1), (2)}		
	1/4-Mile	1/2-Mile	1-Mile
Mainline Travel Time ⁽³⁾ (min)	62.7	62.3	62.3
Average Mainline Speed ⁽³⁾ (mph)	62.2	62.6	62.6
User Cost ⁽⁴⁾ (dollars)	\$5,890	\$6,830	\$12,070

Notes:

- (1) Assumes a disconnected frontage/backage road network.
- (2) A three-mile segment of a four-lane divided arterial - representing a small urban area. Assumes 45 mph mainline posted speed for quarter-mile signal spacing and 65 mph mainline posted speed for half-mile and one-mile signal spacing.
- (3) Mainline travel time for 65-mile corridor with one freestanding urban center.
- (4) User cost for peak hour of the day.

Severing the backage roads resulted in all three signal spacing scenarios having similar travel times and speeds (average through-through speeds dropped by 1.03 mph from the one-mile signal spacing full-service road scenario and through-through speeds dropped by 0.5 mph for half-mile signal spacing scenario). As a result, all three signal spacing scenarios would provide similar performance levels over a 65-mile trip.

However, while the mainline trip times and speeds were nearly equal for the three signal spacing alternatives, the overall system performance measures such as VHT changed significantly. This substantially increased user costs for longer signal spacing alternatives. For example, the VHT for the one-mile spacing alternative more than doubled when frontage roads were severed (increased from 339 to 715 hours). This resulted in user costs increasing by 75 percent for the overall system. These performance results were a product of more circuitry in the roadway network and the fact that trips traveling on the backage roads, at the severed point, were forced back onto or across the mainline. In fact, mainline volumes under this scenario increased significantly over the scenario with full-frontage/backage roadways. For example, the mainline volumes increased approximately 5,000 ADT for the quarter-mile spacing alternative; 7,000 ADT for the one-half mile signal spacing, and 12,800 ADT for the one-mile signal spacing alternative (see Figures 14, 15 and 16). The results demonstrate the importance in developing good local supporting roadway networks. Furthermore, developing these parallel supporting roadway systems become more critical where access is more limited and/or where traffic conditions may approach capacity levels.

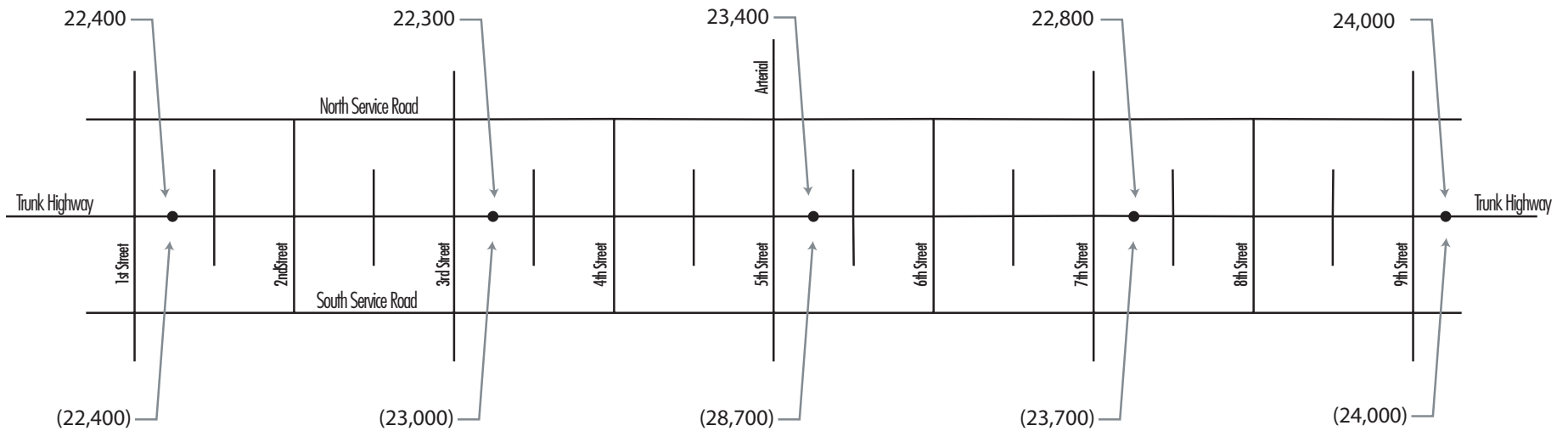

LEGEND⁽¹⁾

- XXX = Full-Service Road Network
- (XXX) = Disconnected Service Road Network
- (1) Average Daily Traffic



MAINLINE VOLUMES: QUARTER-MILE SIGNAL SPACING
Mn/DOT Access Operations Study



Figure 14

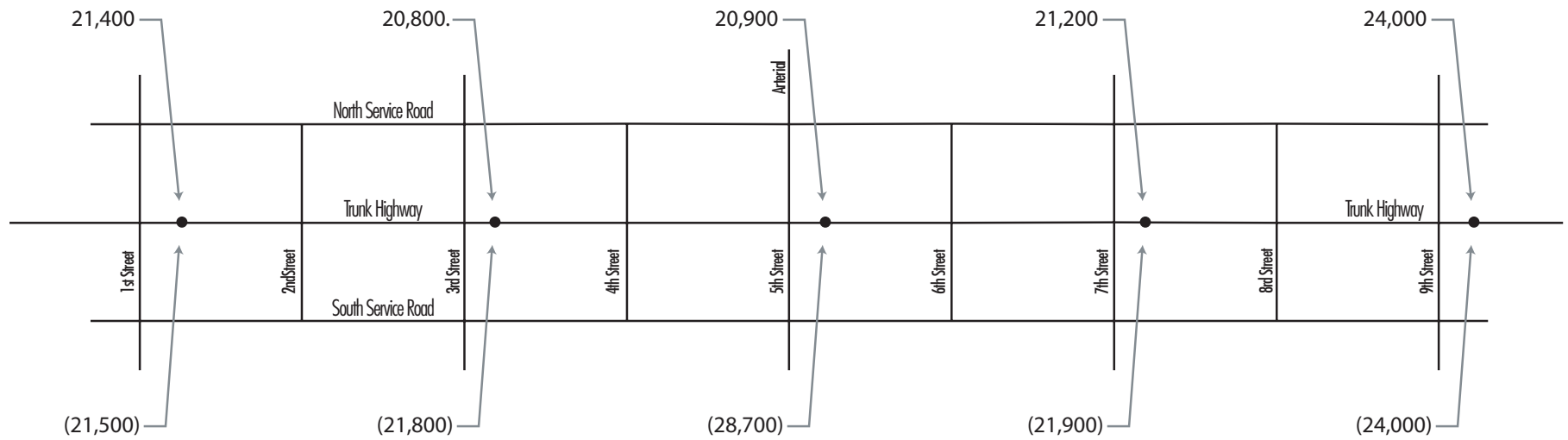

LEGEND⁽¹⁾

XXX = Full-Service Road Network

(XXX) = Disconnected Service Road Network

(1) Average Daily Traffic

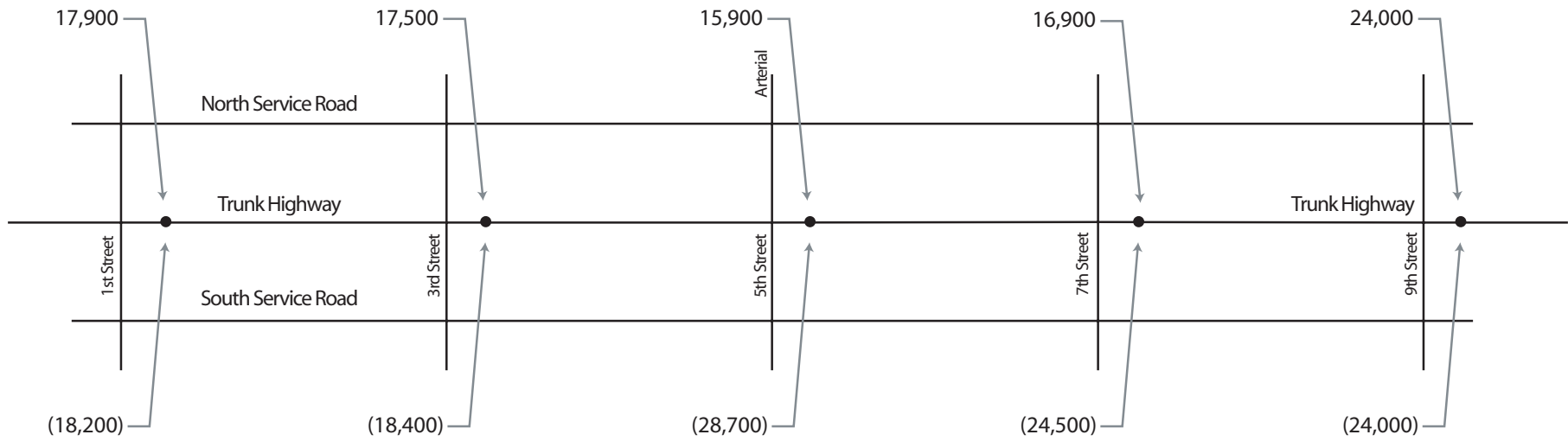

LEGEND⁽¹⁾

XXX = Full-Service Road Network

(XXX) = Disconnected Service Road Network

(1) Average Daily Traffic

2. What if this was a two lane facility, not a four lane roadway?

This scenario was not analyzed; however, the basic findings of the four-lane analysis should still apply to two lane facilities with the following qualifications. The mainline volumes and the level of land use shown in this report may not work for a two-lane facility. However, it is expected that similar patterns and performance results will be achieved for two lane alternatives as long as volumes are at a similar level with respect to capacity.

3. What if the posted speed is 55 mph through the local community? How would this impact the results and/or recommendations?

A speed sensitivity test was run to investigate the variability of results based on changes in the mainline posted speed through the freestanding community. The original analysis was done with a mainline posted speed of 65 mph and the sensitivity test was done using a 55 mph mainline posted speed within the model analysis area (an 18 percent change in posted speed). The sensitivity test was run by first changing the link speeds in the model and then optimizing the signal timing for the one-half and one-mile signal spacing alternatives. The results of this analysis are shown in Table 8 and described below.

The results of the sensitivity analysis indicate that a speed change of this magnitude would have a limited affect on overall travel times and IRC performance. There were no changes in mainline travel times for the one-mile spacing and less than 30 seconds of increase for the one-half mile spacing alternative. This would result in virtually the same performance as the 65-mph analysis. It appeared that impacts of the slower posted speed limit were minimized because the lower speeds allowed for a wider mainline green bandwidth. This actually improved mainline operation (allowed more vehicles into the green band).

**Table 8
Posted Speed Sensitivity Analysis – Free Standing Community ⁽¹⁾**

Mainline ⁽³⁾	Signal Spacing ⁽²⁾	
	1/2-Mile	1-Mile
Through-Through Speed (mph)	41.6 / (39)	46.7 / (45.3)
Through-Through Travel Time (min)	4.4 / (4.8)	3.9 / (3.9)
Mainline Stops (veh)	4,119 / (4,243)	3,113 / (2,929)
Network/System ⁽³⁾		
Vehicle-Miles Traveled (VMT)	6,309 / (6,304)	6,758 / (6,752)
Vehicle-Hours Traveled (VHT)	237 / (237)	339 / (354)
Total Stops (veh)	8,819 / (8,887)	10,503 / (9,722)

Notes: (1) Assumes a full service road network with 55 mph posted speed on mainline.
 (2) A three-mile segment of a four-lane divided arterial - representing a freestanding urban center.
 (3) Numbers are for the peak hour. Assumes optimized cycle lengths.
XX = 65 mph results followed by / (XX) = 55 mph results

On an overall system performance basis, the VMT and VHT numbers did not change significantly. Therefore, user costs are also expected to remain relatively unchanged. Based on the sensitivity tests, there is little evidence to suggest that the initial findings and conclusions would be changed significantly by this speed change.

4. What if there are higher mainline volumes? How would this affect the results? What if there is less intense development?

The current study was developed using mainline volumes of approximately 24,000 vehicles per day for the Freestanding Community scenario, and volumes ranging from 24,000 to 36,000 for the Ten-Mile Commuter Corridor. These volume levels resulted in LOS C or better intersection operations at all mainline intersections. If mainline volumes were increased so that they approached capacity which alternative would function better?

This is a complex question and the results depend on the density of local development and the volume on major cross-streets. Based on results of the study, the one-mile signal spacing network appears to provide more elasticity to address increases in mainline volumes under the following conditions:

- There is relatively low demand on the cross-streets, and this demand is not expected to change significantly in the future.
- There are parallel facilities to handle distribution of local traffic to adjacent land uses, thereby minimizing short and medium length trips on the mainline.

However, if there are relatively high cross-street volumes, and/or significant urbanization is likely to occur over time, the one-half mile spacing will tend to better distribute volumes and reduce the tendency to overload intersections. Tools that have been employed to address capacity issues at intersections include the use of left-in movements upstream of the main intersection, double left-turn lanes, and right-in/right-out access points. If access is controlled to the point that it concentrates traffic to too few intersections, these intersections may become overloaded and all benefits of signal progression may be lost.

Less intense development along the corridor, translates into lower cross-street volumes, unless the cross-street is a significant roadway that serves a large travel shed. As a result, it is likely that the performance of one-half and one-mile alternatives would be positively impacted. Most planning documents suggest that as land use densities increase, transportation networks also must increase to accommodate the increased demands (closer spacing and route redundancy to provide adequate options for traffic to complete their trips). In general, if access points are limited and there are not good parallel facilities to the mainline, it becomes more likely that critical linkages on these facilities will fail much earlier and/or more often due to bottleneck issues.

Appendix A

Additional Traffic Information

Figure A1 (11 x 17 figure, see separate folder)
Design Hour Volumes: Quarter-Mile Signal Spacing (disconnected service roads)

Figure A2 (11 x 17 figure, see separate folder)
Design Hour Volumes: Half-Mile Signal Spacing (disconnected service roads)

Figure A3 (11 x 17 figure, see separate folder)
Design Hour Volumes: One-Mile Signal Spacing (disconnected service roads)

**Mn/DOT Access/Operations Study - Traffic Simulation Observed Through/Through Overall Travel Speeds
(1/4 Mile Signalized Intersection Spacing)**

Full Service Road Network - 45 MPH					
Vehicle ID No,	Time Enter	Time Exit	Elapsed Time	Elapsed Seconds	Overall Speed
202	5:04:20	5:11:17	0:06:57	417	25.9
44	5:04:32	5:09:45	0:05:13	313	34.5
286	5:04:46	5:09:32	0:04:46	286	37.8
277	5:05:12	5:09:48	0:04:36	276	39.1
139	5:05:16	5:11:59	0:06:43	403	26.8
159	5:05:18	5:11:28	0:06:10	370	29.2
330	5:05:26	5:10:47	0:05:21	321	33.6
127	5:05:28	5:09:56	0:04:28	268	40.3
49	5:05:33	5:11:34	0:06:01	361	29.9
263	5:05:42	5:09:46	0:04:04	244	44.3
93	5:05:46	5:09:48	0:04:02	242	44.6
194	5:06:44	5:13:25	0:06:41	411	26.3
326	5:06:27	5:10:34	0:04:07	247	43.7
232	5:06:35	5:13:06	0:06:31	391	27.6
149	5:06:41	5:12:15	0:05:34	334	32.3
Average Overall Speed (MPH) >>					34.4
Standard Deviation (MPH) >>					6.8

Disconnected Service Roads - 45 MPH					
Vehicle ID No,	Time Enter	Time Exit	Elapsed Time	Elapsed Seconds	Overall Speed
187	5:04:41	5:10:28	0:05:47	347	31.1
71	5:05:45	5:12:12	0:06:27	387	27.9
204	5:04:53	5:12:50	0:07:57	479	22.5
44	5:04:55	5:12:43	0:07:48	468	23.1
129	5:04:57	5:09:02	0:04:05	245	44.1
235	5:04:59	5:11:10	0:06:11	371	29.1
297	5:06:03	5:11:42	0:05:39	339	31.9
34	5:06:07	5:14:11	0:08:04	484	22.3
75	5:06:27	5:10:57	0:04:30	270	40.0
256	5:06:29	5:11:33	0:05:04	304	35.5
278	5:07:16	5:11:44	0:04:28	268	40.3
73	5:06:29	5:10:40	0:04:11	251	43.0
135	5:07:53	5:11:55	0:04:02	242	44.6
18	5:07:48	5:13:40	0:05:52	352	30.7
266	5:07:56	5:15:23	0:07:27	447	24.2
Average Overall Speed (MPH) >>					32.7
Standard Deviation (MPH) >>					8.1

**Mn/DOT Access/Operations Study - Traffic Simulation Observed Through/Through Overall Travel Speeds
(full service road network)**

1/2 Mile Signal Spacing - 65 MPH						1 Mile Signal Spacing - 65 MPH					
Vehicle ID No,	Time Enter	Time Exit	Elapsed Time	Elapsed Seconds	Overall Speed	Vehicle ID No,	Time Enter	Time Exit	Elapsed Time	Elapsed Seconds	Overall Speed
41	5:00:13	5:04:22	0:04:09	249	43.4	81	5:00:32	5:04:48	0:04:16	219	49.3
212	5:00:35	5:04:30	0:03:55	235	46.0	60	5:00:34	5:05:48	0:05:14	269	40.1
6	5:00:42	5:04:21	0:03:39	219	49.3	90	5:00:35	5:04:51	0:04:16	219	49.3
76	5:01:04	5:05:10	0:04:06	246	43.9	180	5:00:50	5:04:48	0:03:58	204	52.9
77	5:01:04	5:05:12	0:04:08	248	43.5	268	5:00:52	5:04:46	0:03:54	201	53.7
33	5:00:43	5:05:18	0:04:35	275	39.3	286	5:01:19	5:04:50	0:03:31	181	59.7
147	5:01:05	5:05:24	0:04:19	259	41.7	98	5:01:40	5:05:55	0:04:15	219	49.3
200	5:00:30	5:05:25	0:04:55	295	36.6	37	5:00:57	5:06:02	0:05:05	261	41.4
163	5:00:32	5:05:38	0:05:06	306	35.3	29	5:02:06	5:06:22	0:04:16	219	49.3
65	5:01:27	5:05:48	0:04:21	261	41.4	7	5:02:35	5:06:24	0:03:49	196	55.1
167	5:01:17	5:05:46	0:04:29	269	40.1	270	5:02:49	5:07:17	0:04:28	230	47.0
144	5:01:38	5:06:42	0:05:04	304	35.5	298	5:02:51	5:06:25	0:03:34	183	59.0
110	5:01:38	5:06:21	0:04:43	283	38.2	302	5:02:53	5:07:58	0:05:05	261	41.4
172	5:02:57	5:06:34	0:03:37	217	49.8	141	5:03:11	5:07:44	0:04:33	234	46.2
62	5:02:01	5:06:26	0:04:25	265	40.8	93	5:03:17	5:07:37	0:04:20	223	48.4
						147	5:03:27	5:07:39	0:04:12	216	50.0
						278	5:03:38	5:08:58	0:05:20	274	39.4
						182	5:03:51	5:09:02	0:05:11	267	40.4
						121	5:03:57	5:08:59	0:05:02	259	41.7
						17	5:04:01	5:07:41	0:03:40	189	57.1
						214	5:04:03	5:09:04	0:05:01	258	41.9
						331	5:04:14	5:09:01	0:04:47	246	43.9
						248	5:04:27	5:09:26	0:04:59	256	42.2
						119	5:04:41	5:09:21	0:04:40	240	45.0
						225	5:04:44	5:09:23	0:04:39	239	45.2
						226	5:04:46	5:09:28	0:04:42	242	44.6
						82	5:04:51	5:09:28	0:04:37	237	45.6
						34	5:05:04	5:10:29	0:05:25	279	38.7
						221	5:05:18	5:10:32	0:05:14	269	40.1
						328	5:05:28	5:10:13	0:04:45	244	44.3
Average Overall Speed (MPH) >>					41.6	Average Overall Speed (MPH) >>					46.7
Standard Deviation (MPH) >>					4.5	Standard Deviation (MPH) >>					5.9

**Mn/DOT Access/Operations Study - Traffic Simulation Observed Through/Through Overall Travel Speeds
(Scenario with disconnected service roads)**

1/2 Mile Signal Spacing - 65 MPH						1 Mile Signal Spacing - 65 MPH					
Vehicle ID No,	Time Enter	Time Exit	Elapsed Time	Elapsed Seconds	Overall Speed	Vehicle ID No,	Time Enter	Time Exit	Elapsed Time	Elapsed Seconds	Overall Speed
295	5:00:01	5:04:31	0:04:30	270	40.0	150	5:00:21	5:05:47	0:05:26	326	33.1
116	5:00:04	5:05:26	0:05:22	322	33.5	351	5:00:32	5:05:31	0:04:59	259	41.7
64	5:00:13	5:05:41	0:05:28	328	32.9	24	5:00:33	5:04:33	0:04:00	240	45.0
330	5:00:16	5:05:50	0:05:34	334	32.3	108	5:00:46	5:05:08	0:04:22	262	41.2
211	5:00:21	5:05:34	0:05:13	313	34.5	151	5:00:49	5:06:04	0:05:15	315	34.3
321	5:00:32	5:04:49	0:04:17	257	42.0	130	5:01:11	5:05:49	0:04:38	278	38.8
150	5:00:33	5:05:12	0:04:39	279	38.7	321	5:01:32	5:05:47	0:04:15	255	42.4
319	5:00:46	5:05:54	0:05:08	308	35.1	208	5:00:53	5:06:02	0:05:09	309	35.0
101	5:00:49	5:05:40	0:04:51	291	37.1	144	5:02:01	5:06:51	0:04:50	290	37.2
269	5:01:11	5:06:39	0:05:28	328	32.9	296	5:02:28	5:08:12	0:05:44	344	31.4
317	5:01:32	5:06:59	0:05:27	327	33.0	191	5:02:33	5:08:20	0:05:47	347	31.1
320	5:00:53	5:05:52	0:04:59	299	36.1	385	5:02:47	5:07:48	0:05:01	301	35.9
311	5:02:01	5:07:30	0:05:29	329	32.8	241	5:02:51	5:06:55	0:04:04	244	44.3
81	5:02:28	5:06:58	0:04:30	270	40.0	45	5:03:08	5:08:29	0:05:21	321	33.6
252	5:02:33	5:06:57	0:04:24	264	40.9	30	5:03:11	5:07:59	0:04:48	288	37.5
304	5:02:47	5:07:17	0:04:30	270	40.0	299	5:03:19	5:07:53	0:04:34	274	39.4
43	5:02:51	5:08:14	0:05:23	323	33.4	357	5:03:32	5:09:23	0:05:51	351	30.8
87	5:03:08	5:08:37	0:05:29	329	32.8	255	5:03:43	5:08:46	0:05:03	303	35.6
268	5:03:11	5:08:05	0:04:54	294	36.7	183	5:03:52	5:08:54	0:05:02	302	35.8
167	5:03:19	5:08:14	0:04:55	295	36.6	311	5:04:03	5:08:03	0:04:00	240	45.0
104	5:03:32	5:08:35	0:05:03	303	35.6	133	5:04:09	5:09:32	0:05:23	323	33.4
300	5:03:43	5:09:10	0:05:27	327	33.0	167	5:04:12	5:09:03	0:04:51	291	37.1
47	5:03:52	5:09:26	0:05:34	334	32.3	322	5:04:25	5:09:54	0:05:29	329	32.8
340	5:04:03	5:09:01	0:04:58	298	36.2	304	5:04:33	5:09:22	0:04:49	289	37.4
231	5:04:09	5:08:06	0:03:57	237	45.6	227	5:04:41	5:10:16	0:05:35	335	32.2
102	5:04:12	5:09:11	0:04:59	299	36.1	62	5:04:44	5:09:55	0:05:11	311	34.7
169	5:04:25	5:09:53	0:05:28	328	32.9	329	5:04:49	5:10:39	0:05:50	350	30.9
282	5:04:33	5:08:33	0:04:00	240	45.0	238	5:05:01	5:10:04	0:05:03	303	35.6
61	5:04:41	5:10:08	0:05:27	327	33.0	245	5:05:16	5:09:55	0:04:39	279	38.7
207	5:04:44	5:09:38	0:04:54	294	36.7	71	5:05:24	5:11:09	0:05:45	345	31.3
Average Overall Speed (MPH) >>					36.3	Average Overall Speed (MPH) >>					36.4
Standard Deviation (MPH) >>					3.7	Standard Deviation (MPH) >>					4.3

Appendix B

Glossary of Terms

General Terms

Control Delay – The control delay is that portion of total delay for a vehicle approaching and entering a signalized intersection that is attributable to the traffic signal operation. Control delay includes the delays of initial deceleration, move-up time in the queue, stops and reaccelerating.

Minimum Mainline Through Bandwidth – The shortest through-band time allowed for the mainline through movement phases (usually defined in seconds and accounts for speed differentials, vehicle mix, etc.).

Minimum Mainline Through Green Time – The shortest green time allowed for the mainline through movement phases (usually defined as a percent of total cycle length and takes into account mainline approach speed and volume).

Platoon Dispersion – With platoon dispersion, it is assumed that some vehicles will go faster or slower than the defined speed and platoons spread out over greater distances. The result of platoon dispersion is that traffic signal coordination and progression has less beneficial impact on longer segments between signals.

Through Bandwidth – The through-band is the space between a pair of parallel speed lines that delineates a progressive movement on a time-space diagram. The width of the through-band in seconds indicates the period of time available for traffic to flow within the band. The bigger the through bandwidth, the more leeway the driver has, in terms of speed and time, to get into the bandwidth or stay within the bandwidth. Narrow bandwidths have very little margin for error and can trap or cut off platoons of vehicles.

**Table 4 - Mn/DOT Access/Operations Study
Four-Lane Divided Trunk Highway
Short Segment - High Speed - High Volume
Traffic Signal Spacing / System Efficiency Comparison**

65 mph/High Volume Scenarios	8A	8B	8C	9A	9B	9C
Measures of Effectiveness	Signalized Intersection Spacing					
<i>Mainline "Through" Traffic MOEs</i>	<u>1/2 Mile</u>			<u>1 Mile</u>		
Optimized Signal Cycle (sec)	90	120	150	90	120	150
Minimum Through Bandwidth	29%	24%	30%	26%	23%	29%
Minimum Through Green Time	43%	45%	45%	32%	45%	45%
Average Speed (mph)	36.7	38.3	37.2	38.4	38.3	38.1
Total Stops	2,479	1,901	1,976	1,633	1,504	1,382
Stops per Vehicle	0.32	0.26	0.27	0.47	0.45	0.42
Average Delay per Vehicle (sec)	9.5	8.8	9.6	15.1	15.6	15.0
<i>Total Network Traffic MOEs</i>						
Vehicle Miles of Travel	6,316.7	6,272.7	6,119.6	6,561.5	6,486.8	6,630.2
Vehicle Hours of Travel	234.2	237.6	244.1	333.6	401.2	364.0
Total Stops	8,783	8,154	8,021	9,670	11,204	10,278
Stops per Vehicle	1.32	1.21	1.23	2.08	2.36	2.13
Average Delay per Vehicle (sec)	45.9	47.6	54.2	124.6	174.3	141.1

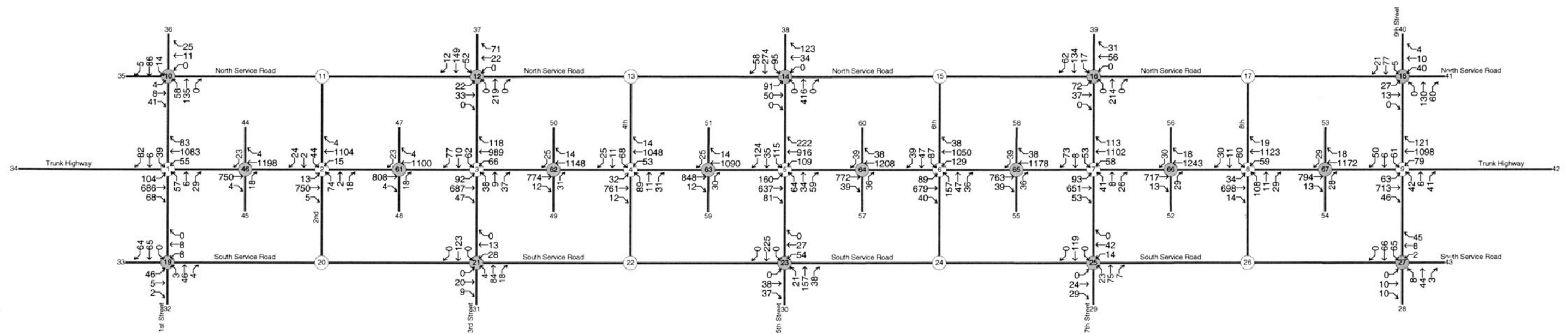

Design Hour Volumes: Quarter-mile Signal Spacing

Figure 8

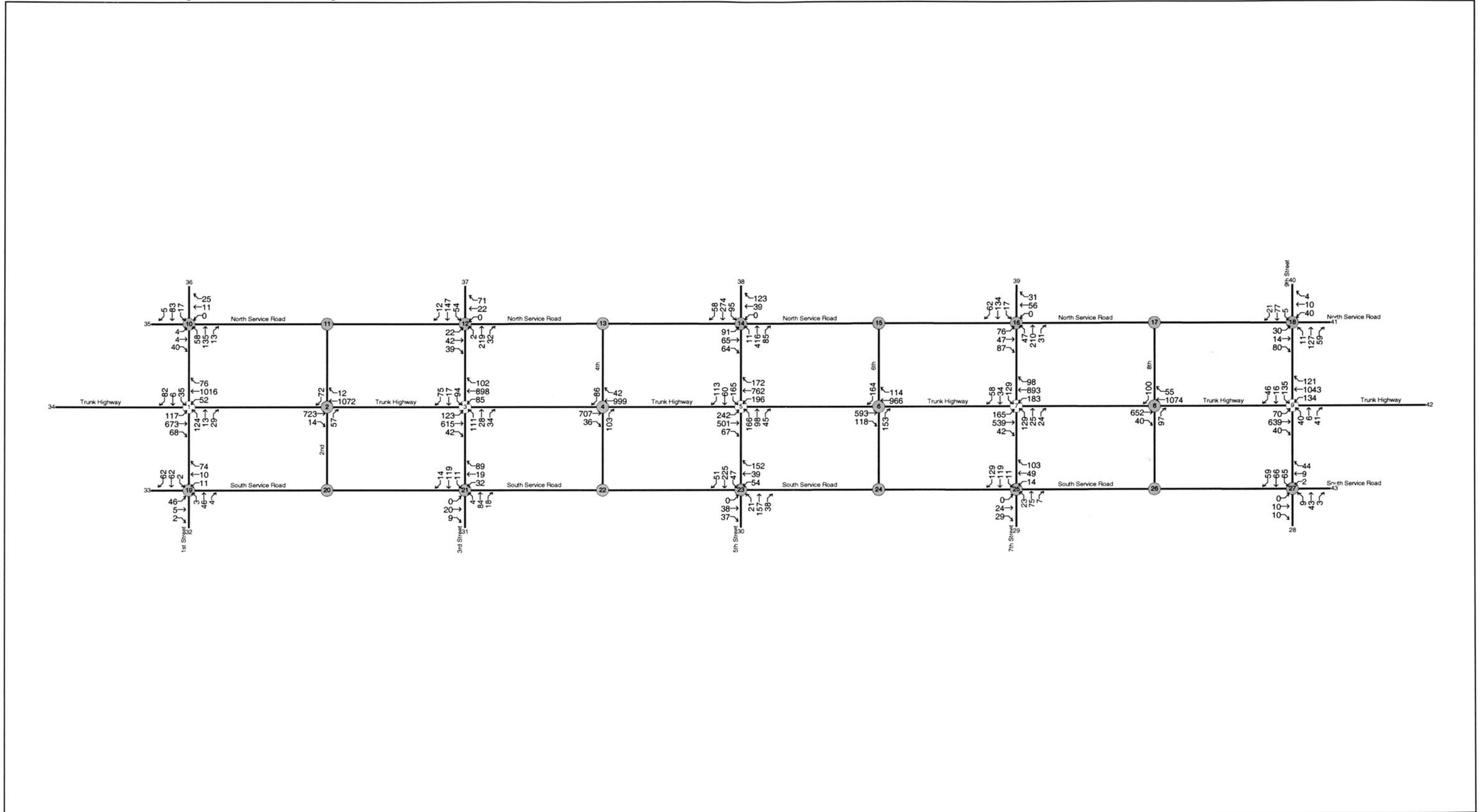

Design Hour Volumes: Half-mile Signal Spacing

Figure 9

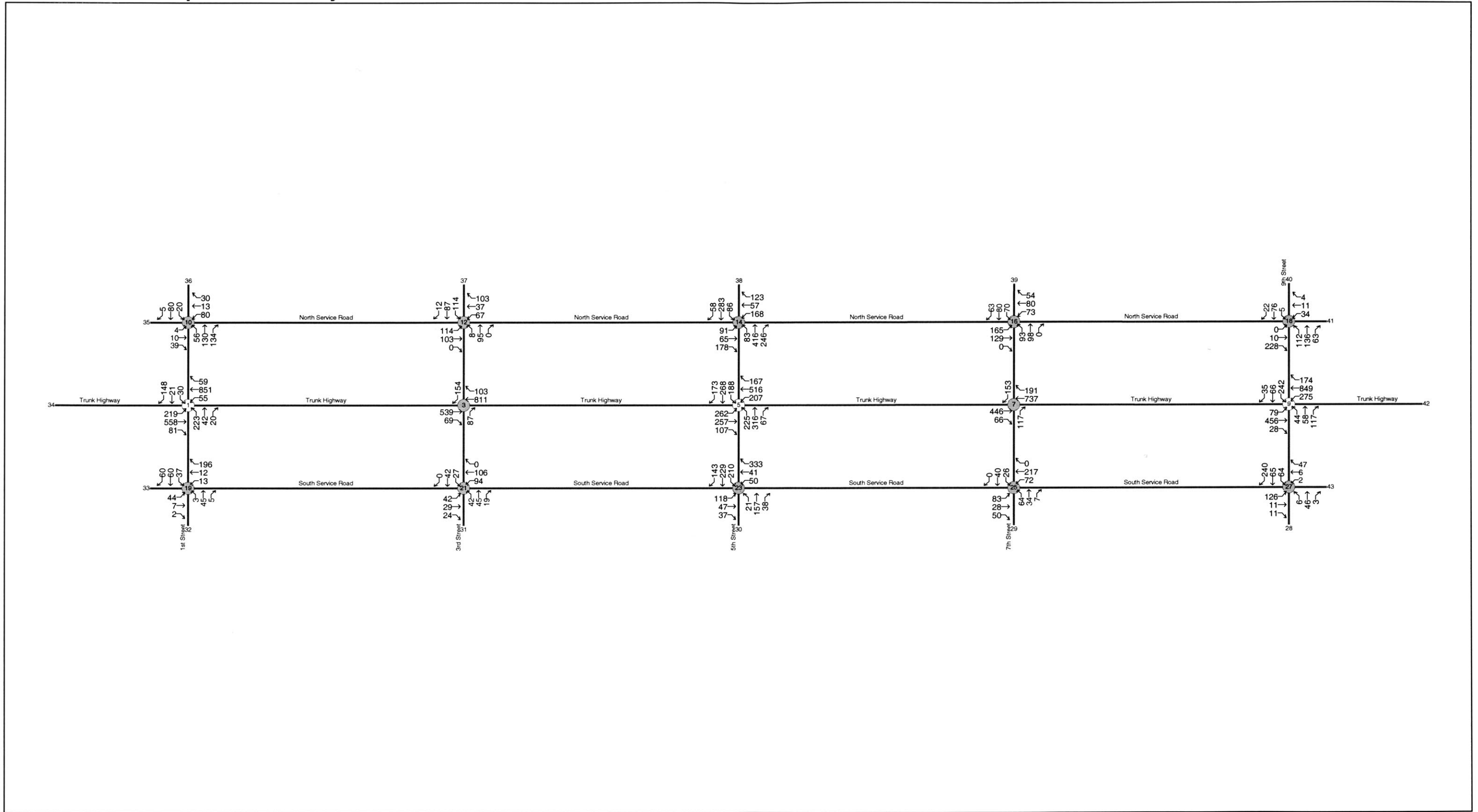

Design Hour Volumes: One-mile Signal Spacing

Figure 10

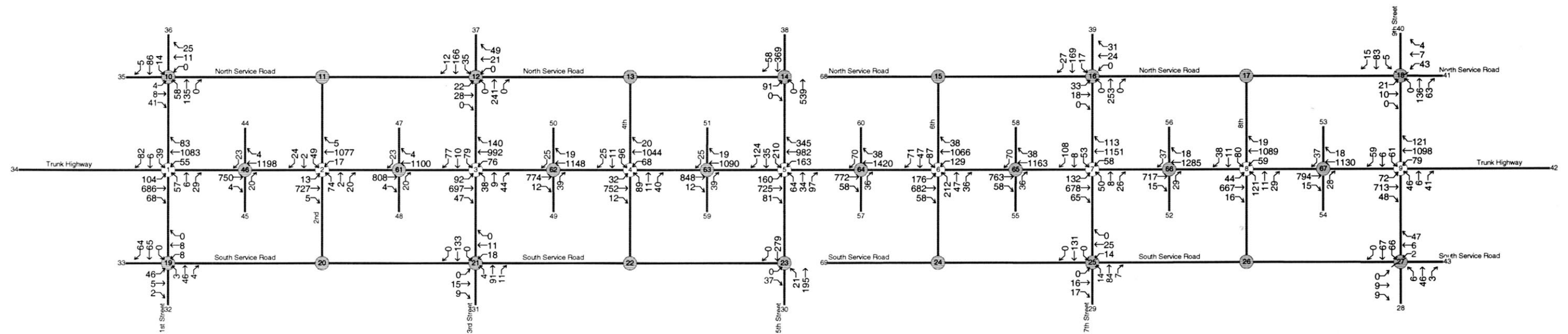

Design Hour Volumes: Quarter-mile Signal Spacing (disconnected service roads)

Figure A-1

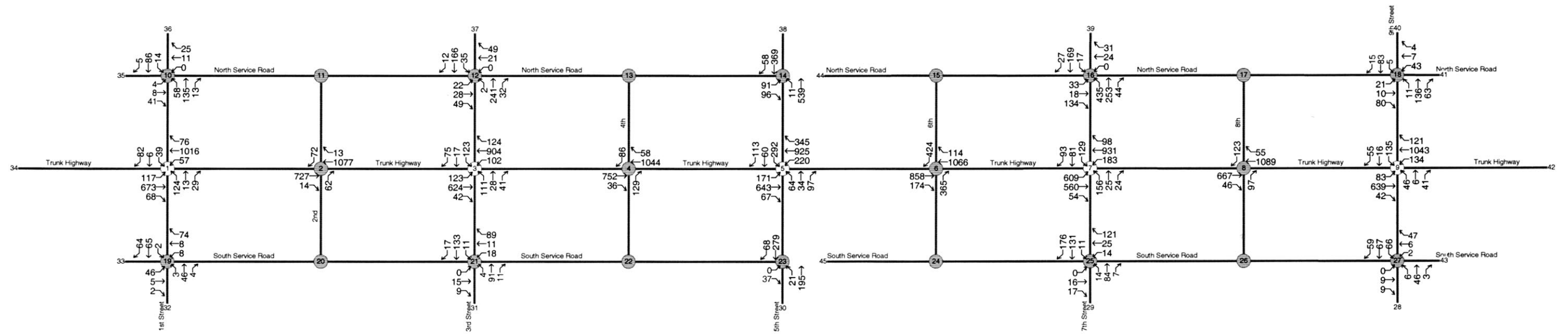

Design Hour Volumes: Half-mile Signal Spacing (disconnected service roads)

Figure A-2

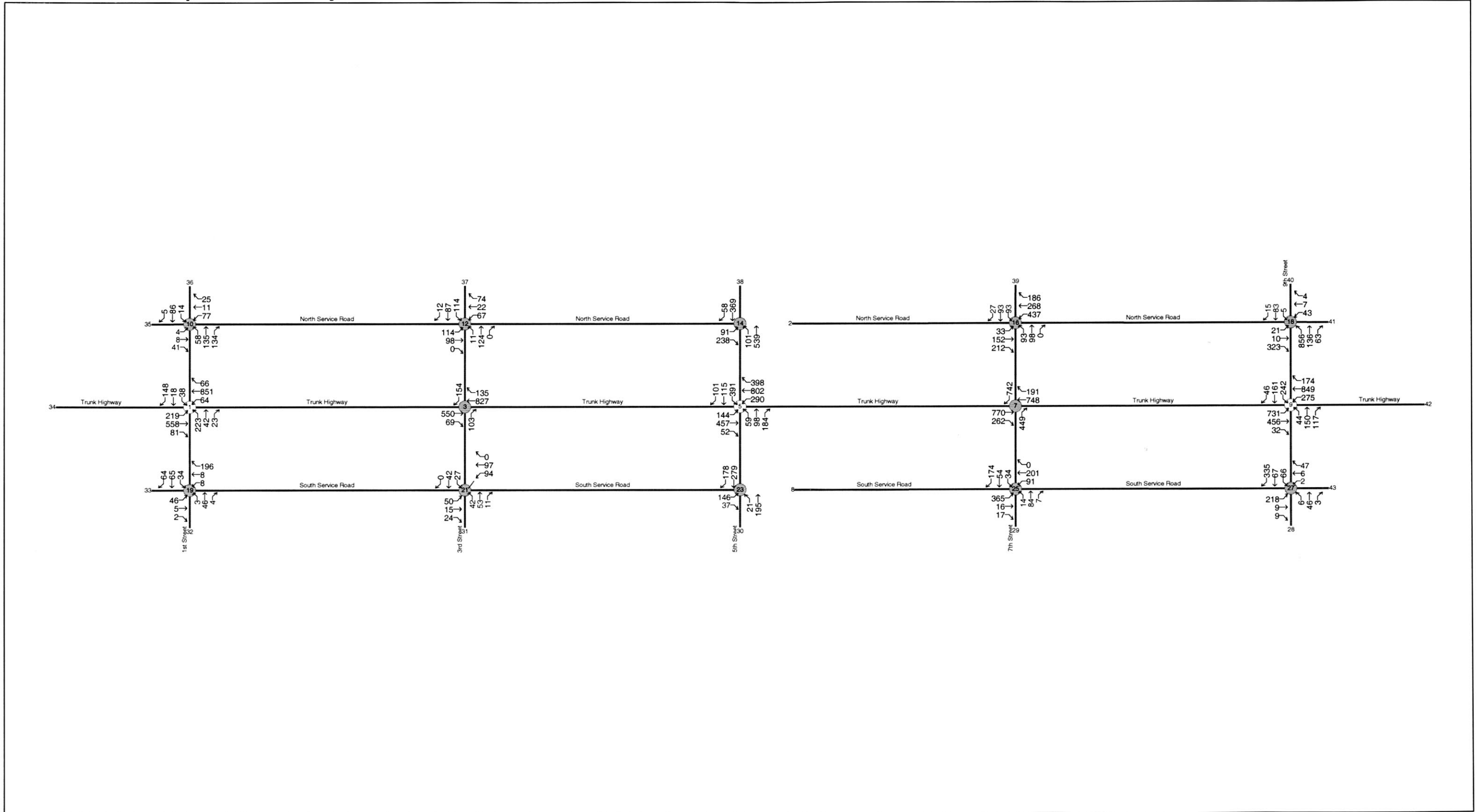

Design Hour Volumes: One-mile Signal Spacing (disconnected service roads)

Figure A-3