An Integrated Study of Pervious Concrete Mixture Design for Wearing Course Applications

National Concrete Pavement
Technology Center



**Final Report
October 2011**

Sponsored through

Federal Highway Administration (DTFH61-06-H-00011 (Work Plan 10))
and the Ready Mixed Concrete (RMC) Research & Education Foundation

IOWA STATE UNIVERSITY
Institute for Transportation

About the National CP Tech Center

The mission of the National Concrete Pavement Technology (CP Tech) Center is to unite key transportation stakeholders around the central goal of advancing concrete pavement technology through research, tech transfer, and technology implementation.

About the Institute for Transportation

The mission of the Institute for Transportation (InTrans) at Iowa State University is to develop and implement innovative methods, materials, and technologies for improving transportation efficiency, safety, reliability, and sustainability while improving the learning environment of students, faculty, and staff in transportation-related fields.

Disclaimer Notice

The contents of this report reflect the views of the authors, who are responsible for the facts and the accuracy of the information presented herein. The opinions, findings, and conclusions expressed in this publication are those of the authors and not necessarily those of the sponsors.

The sponsors assume no liability for the contents or use of the information contained in this document. This report does not constitute a standard, specification, or regulation.

The sponsors do not endorse products or manufacturers. Trademarks or manufacturers' names appear in this report only because they are considered essential to the objective of the document.

Non-Discrimination Statement

Iowa State University does not discriminate on the basis of race, color, age, religion, national origin, sexual orientation, gender identity, genetic information, sex, marital status, disability, or status as a U.S. veteran. Inquiries can be directed to the Director of Equal Opportunity and Compliance, 3280 Beardshear Hall, (515) 294-7612.

Technical Report Documentation Page

1. Report No. DTFH61-06-H-00011 Work Plan 10		2. Government Accession No.		3. Recipient's Catalog No.	
4. Title and Subtitle An Integrated Study of Pervious Concrete Mixture Design for Wearing Course Applications				5. Report Date October 2011	
				6. Performing Organization Code	
7. Author(s) Vernon R. Schaefer and John T. Kevern				8. Performing Organization Report No.	
9. Performing Organization Name and Address National Concrete Pavement Technology Center Iowa State University 2711 South Loop Drive, Suite 4700 Ames, IA 50010-8664				10. Work Unit No. (TRAIS)	
				11. Contract or Grant No.	
12. Sponsoring Organization Name and Address Federal Highway Administration U.S. Department of Transportation 1200 New Jersey Avenue SE Washington, DC 20590				13. Type of Report and Period Covered Final Report	
				14. Sponsoring Agency Code	
15. Supplementary Notes Visit www.cptechcenter.org for color PDF files of this and other research reports.					
16. Abstract <p>This report presents the results of the largest and most comprehensive study to date on portland cement pervious concrete (PCPC). It is designed to be widely accessible and easily applied by designers, producers, contractors, and owners.</p> <p>The project was designed to begin with pervious concrete best practices and then to address the unanswered questions in a systematic fashion to allow a successful overlay project. Consequently, the first portion of the integrated project involved a combination of fundamental material property investigations, test method development, and addressing constructability issues before actual construction could take place. The second portion of the project involved actual construction and long-term testing before reporting successes, failures, and lessons learned.</p> <p>The results of the studies conducted show that a pervious concrete overlay can be designed, constructed, operated, and maintained. A pervious concrete overlay has several inherent advantages, including reduced splash and spray and reduced hydroplaning potential, as well as being a very quiet pavement. The good performance of this overlay in a particularly harsh freeze-thaw climate, Minnesota, shows pervious concrete is durable and can be successfully used in freeze-thaw climates with truck traffic and heavy snow plowing.</p>					
17. Key Words concrete mixtures—fly ash—pervious concrete—portland cement—silica fume—slag—ternary mixtures				18. Distribution Statement No restrictions.	
19. Security Classification (of this report) Unclassified.		20. Security Classification (of this page) Unclassified.		21. No. of Pages 156	22. Price NA

AN INTEGRATED STUDY OF PERVIOUS CONCRETE MIXTURE DESIGN FOR WEARING COURSE APPLICATIONS

Final Report
October 2011

Principal Investigator

Vernon R. Schaefer
Professor of Civil, Construction, and Environmental Engineering
Iowa State University

Co-Principal Investigator

John T. Kevern
Assistant Professor of Civil Engineering
University of Missouri-Kansas City

Kejin Wang

Professor of Civil, Construction, and Environmental Engineering
Iowa State University

Research Assistants

Heath Cutler and Bin Tong

Project Manager

Paul Wiegand, Transportation Research Engineer
National Concrete Pavement Technology Center/Institute for Transportation
Iowa State University

Authors

Vernon R. Schaefer and John T. Kevern

Sponsored through

Federal Highway Administration DTFH61-06-H-00011 Work Plan 10
and the Ready Mixed Cement (RMC) Research and Education Foundation

A report from

**National Concrete Pavement Technology Center
Institute for Transportation**

Iowa State University

2711 South Loop Drive, Suite 4700

Ames, IA 50010-8664

Phone: 515-294-8103 Fax: 515-294-0467

www.cptechcenter.org

TABLE OF CONTENTS

ACKNOWLEDGMENTS	xiii
EXECUTIVE SUMMARY	xv
Pervious Concrete Air Entrainment	xv
Measuring Pervious Concrete Workability	xv
Pervious Concrete Overlay Mixture Development	xvi
Pervious Concrete Curing and Surface Durability	xvi
Pervious Concrete Durability to Deicers	xvi
Design Considerations to Reduce Potential Clogging	xvii
Pervious Concrete Overlay Construction	xvii
Pervious Concrete Overlay Field Durability and Performance	xvii
Pervious Concrete Overlay Noise Characteristics	xviii
Summary and Conclusions	xviii
CHAPTER 1. STUDY OVERVIEW	1
Introduction to the Study	1
Background	2
Objectives of the Integrated Study	6
CHAPTER 2. RESEARCH PLAN	8
Task 1. Optimize Pervious Concrete Mixtures for Mechanized Placement and Higher Strengths	8
Task 2. Evaluate the Effect of Deicing on Pervious Concrete Durability	9
Task 3. Determine the Need for Air Entrainment and the Effect of Air Entrainment on Durability	9
Task 4. Workability and Curing Studies	9
Task 5. Abrasion Resistance Rests and Test Development	10
Task 6. Clogging and Permeability Test Development	10
Task 7. Overlay Design Procedures Development	10
Task 8. Field Trials	10
Task 9. Noise Studies	11
Task 10. Preparation of Final Report	11
CHAPTER 3. APPROPRIATENESS AND EFFECT OF AIR ENTRAINMENT ON PERVIOUS CONCRETE DURABILITY	12
Introduction	12
Material Properties and Mixture Proportions	12
Sample Preparation	13
Testing Procedures	14
Results and Discussion	15
Conclusions on Air Entrainment	22

CHAPTER 4. DEVELOPMENT OF A METHOD TO DETERMINE WORKABILITY	23
Introduction.....	23
Gyratory Test Method Development	24
Device Modification	24
Determination of the Maximum Number of Gyration	24
Characterization of Workability Using the Gyratory Compaction Curve	26
Mixture Proportioning and Processing	28
Test Results.....	28
General Properties of the Pervious Concrete Specimens.....	28
Factors That Influence Pervious Concrete Workability.....	30
Effect of Binder-to-Aggregate Ratio	30
Effect of Water-to-Cement Ratio.....	31
Effect of Mixing Time	32
Classification of Pervious Concrete Placeability.....	34
Conclusions from Workability Test Development	35
 CHAPTER 5. DEVELOPMENT OF PERVIOUS CONCRETE MIXTURES FOR MECHANIZED PLACEMENT	 36
Concrete Materials and Mixture Proportions.....	37
Testing Procedures.....	40
Strength and Durability.....	41
Sample Placement and Compaction Density	41
Results and Discussion	41
Workability and Strength Performance	43
The Selected PCPC Mixture and Properties	47
Freeze-Thaw Durability and Surface Durability.....	48
Mixture Proportioning Conclusions.....	49
 CHAPTER 6. EFFECT OF CURING ON MECHANICAL PROPERTIES AND SURFACE DURABILITY	 51
Introduction.....	51
Testing Procedures.....	51
Abrasion of Reference Concrete.....	53
Field Trial Mixture Proportions	54
Sample Preparation and Curing	55
Results and Discussion	58
Conclusions from the Curing Evaluation.....	61
 CHAPTER 7. EFFECT OF DEICERS ON PERVIOUS CONCRETE DURABILITY	 62
Introduction.....	62
Materials and Mixture Proportions	63
Concrete Materials	63
Deicing Chemicals.....	63
Sample Preparation and Test Methods	63

Saturated Test Method	64
Drained Test Method	65
Results and Discussion	66
Saturated Test Method (Severe Deicing Chemical Application).....	66
Compressive Strength	69
Drained Test Method	70
Conclusions from Deicer Testing	71
CHAPTER 8. CLOGGING EFFECTS FOR MAINTENANCE PRACTICES	72
Introduction.....	72
Laboratory Experimental Plan	73
Case A: Small Sedimentation Load	75
Case B: High Sedimentation Load.....	75
Test Results and Analysis	76
Case A: Small Sedimentation Results.....	76
Case B: Worst (Large) Sedimentation Results	80
Discussion.....	86
Effect of Sedimentation Materials	86
Effect of Porosity of the PCPC	86
Effect of Rehabilitation Methods.....	86
Design Considerations and Maintenance Strategy for PCPC Pavement Subjected to Clogging Issues.....	90
Sand.....	90
Cohesive Materials.....	91
Blended Materials	91
CHAPTER 9. DEVELOPMENT OF AN OVERLAY DESIGN METHODOLOGY	92
Introduction.....	92
Laboratory Overlay Bond Strength Testing.....	92
Field Investigation Related to Overlay Design.....	94
Bonding.....	94
Cracking.....	95
Design Recommendations for Future Pervious Concrete Overlays	95
CHAPTER 10. PERVIOUS OVERLAY CONSTRUCTION AT MNROAD.....	97
Introduction to Overlay Construction	97
MnROAD Facility	98
Pervious Concrete Overlay Project.....	98
Construction.....	99
Preparation	99
Concrete Placement	101
CHAPTER 11. FIELD CONDITION INVESTIGATION RESULTS.....	105
Introduction to Field Investigation.....	105

Field Condition Survey Background	105
Observed Defects and Distresses	109
Joint Deterioration	109
Stretch Mark.....	111
Sealed Surface.....	112
Longitudinal Crack	113
Transverse Crack	114
Summary of the Condition Surveys.....	115
Discussion of Condition Survey Results with Consideration for Construction Practices	118
Flow Characteristics.....	122
Summary of Condition Survey Results.....	125
 CHAPTER 12. OVERLAY NOISE CHARACTERISTICS	 126
Introduction.....	126
Sound Intensity Testing Results.....	128
Sound Intensity Conclusions and Recommendations	130
 CHAPTER 13. CONCLUSIONS AND FUTURE RESEARCH	 131
Future Research	131
 REFERENCES	 133

LIST OF FIGURES

Figure 1. Relationship between pervious concrete void ratio, permeability, and seven-day compressive strength for all mixes placed using regular compaction energy	4
Figure 2. Results of freeze-thaw durability.....	4
Figure 3. Comparison of results with two compaction energies.....	5
Figure 4. RapidAir device.....	15
Figure 5. Images of typical pervious concrete samples	17
Figure 6. Total air and entrained air for pea gravel aggregate.....	19
Figure 7. Air void distribution in the pea gravel mixtures.....	19
Figure 8. Cumulative air content of pea gravel mixtures.....	20
Figure 9. Total air and entrained air for limestone aggregate.....	20
Figure 10. Air void distribution in the limestone mixtures.....	21
Figure 11. Cumulative air content of limestone mixtures.....	21
Figure 12. Freeze-thaw durability of the pea gravel mixtures	22
Figure 13. Typical compaction density curve.....	24
Figure 14. Samples compacted at different gyrations (gyr).....	25
Figure 15. Definition of workability index parameters	27
Figure 16. Relationship between voids and unit weight of pervious concrete samples made with gyratory compaction	29
Figure 17. Relationship between voids and splitting tensile strength.....	30
Figure 18. Effect of binder-to-aggregate ratio on placeability index parameters	31
Figure 19. Effect of w/c on workability and compactibility	32
Figure 20. Effect on workability with increased mixing time	33
Figure 21. Effect on placeability of mixing time	34
Figure 22. Binder-to-aggregate ratio versus workability, strength, and porosity	43
Figure 23. Effect of water-to-cement ratio on workability, strength, and porosity	44
Figure 24. Effect of fine aggregate content on workability, strength, and porosity	44
Figure 25. Effects of SCMs on strength (B24["x"]-S10-CS1.5-w/c0.29)	45
Figure 26. Effect of admixtures on strength (B24[50,35,15]-S10-CS1.5-w/c0.29)	46
Figure 27. Effect of fiber type and addition rate on workability	47
Figure 28. Effects of SCMs on workability (B24["x"]-S10-CS1.5-w/c0.29).....	47
Figure 29. Compaction density relationships.....	48
Figure 30. Laboratory testing of the selected mixture	48
Figure 31. Freeze-thaw durability of the selected mixtures.....	49
Figure 32. Abrasion apparatus and cutting head.....	52
Figure 33. Surface before and after abrasion	52
Figure 34. Abrasion results for calibration specimens.....	54
Figure 35. Finishing using a roller screed.....	56
Figure 36. Fresh concrete with no curing compound	56
Figure 37. Aggregate base at test location	57
Figure 38. Initial beam curing.....	57
Figure 39. Effect of curing regime on control concrete mixture properties	60
Figure 40. Modified mixture response to curing regime	60
Figure 41. Mass change of PCPC after freeze-thaw cycling at 54 cycles	66
Figure 42. Mass loss of nonlatex PCPC with freeze-thaw cycles.....	67

Figure 43. Mass loss of the latex-modified PCPC with freeze-thaw cycles	68
Figure 44. PCPC samples after 54 freeze-thaw cycles in calcium chloride solution	68
Figure 45. Compressive strength of nonlatex pervious concrete	69
Figure 46. Compressive strength of latex-modified pervious concrete	70
Figure 47. Mass change comparison of both deicer application methods at 54 cycles	70
Figure 48. Three sediment materials used: sand (left), silty clay (middle), and silty clay sand (right)	75
Figure 49. Permeability of specimens subjected to sand sediments and cleaned by pressure washing	79
Figure 50. Sand specimens, 15 percent porosity, cleaned by three rehabilitation methods	87
Figure 51. Sand specimens, 20 percent porosity, cleaned by three rehabilitation methods	88
Figure 52. Sand specimens, 25 percent porosity, cleaned by three rehabilitation methods	88
Figure 53. Silty clay sand specimens, 15 percent porosity, cleaned by three rehabilitation methods	89
Figure 54. Silty clay sand specimens, 20 percent porosity, cleaned by three rehabilitation methods	89
Figure 55. Silty clay sand specimens, 25 percent porosity, cleaned by three rehabilitation methods	90
Figure 56. Overlay bond strength test setup	93
Figure 57. Determination of bonding from core samples	95
Figure 58. Section view and plan view of pervious concrete overlay	100
Figure 59. Placement of pervious concrete overlay using roller-screed	102
Figure 60. Completed surface of pervious overlay and covering with two layers of plastic	103
Figure 61. Representative surface	104
Figure 62. 2009 condition survey	107
Figure 63. 2010 condition survey	108
Figure 64. 2011 condition survey	109
Figure 65. High severity level joint deterioration	110
Figure 66. Stretch mark example	112
Figure 67. Surface sealed on Panel 4 by wet mixture or over compaction	113
Figure 68. Longitudinal crack from heavy vehicles or loading repetitions	114
Figure 69. Transverse cracking on Panel 3	115
Figure 70. Example of double-jointing	119
Figure 71. Observation of stretch marking on fresh pavement	120
Figure 72. Jointing on fresh pavement	121
Figure 73. Pooled water before placement	122
Figure 74. NCAT infiltration test device (2009)	123
Figure 75. Overlay bonding	124
Figure 76. Sound intensity probe positions with respect to the tire-pavement interface (Rasmussen et al. 2011)	126
Figure 77. OBSI configuration with dual sound intensity probes (Rasmussen et al. 2011)	127
Figure 78. Normalized distributions of OBSI noise levels for conventional pavement textures (Rasmussen et al. 2008)	128
Figure 79. Frequency versus intensity for Cell 39, outside environmental lane and inside traffic lane, July 22, 2009	129

LIST OF TABLES

Table 1. Coarse aggregate properties.....	13
Table 2. Mixture proportions.....	13
Table 3. Concrete testing results.....	16
Table 4. Variation of RapidAir tests for a typical sample.....	17
Table 5. Air void characteristics.....	18
Table 6. Mixture proportions.....	25
Table 7. Degree of compaction versus different compaction pressures.....	26
Table 8. Determination of maximum curvature.....	27
Table 9. Gyratory-compacted sample properties (baseline mixture).....	29
Table 10. Gyratory results for pervious concrete with different binder-to-aggregate ratios.....	30
Table 11. Gyratory results for pervious concrete with different w/c ratios.....	32
Table 12. Ranges of pervious concrete gyratory values.....	34
Table 13. Mixture matrix summary.....	37
Table 14. PCPC mixture proportions for variables related to basic concrete materials.....	39
Table 15. PCPC test results.....	42
Table 16. Selected mixtures and their test results.....	43
Table 17. Calibration mixture proportions.....	54
Table 18. Mixture proportions.....	55
Table 19. Curing regimes.....	55
Table 20. Climatic data for curing duration (ISU 2006).....	58
Table 21. Beam test results.....	59
Table 22. Saturated test method—Experiment regimen.....	64
Table 23. Drained test method—Experiment regimen.....	65
Table 24. Changes in coefficient of permeability in specimens at different states of the Case A sedimentation test.....	78
Table 25. Changes in coefficient of permeability of the Case B sediments test (by pressure washing).....	83
Table 26. Changes in coefficient of permeability of the Case B sediments test (by vacuuming).....	84
Table 27. Changes in coefficient of permeability of the Case B sediments test (by pressure washing and vacuuming).....	85
Table 28. Bond strength testing results.....	94
Table 29. Bonding of core samples.....	95
Table 30. Observed joint deterioration.....	111
Table 31. Transverse crack developments in years of 2009, 2010, and 2011.....	114
Table 32. Condition survey interpretation.....	116
Table 33. Infiltration and permeability of pervious concrete overlay 2009.....	123
Table 34. Infiltration of pervious concrete overlay 2010.....	125
Table 35. Infiltration and permeability of pervious concrete overlay 2011.....	125
Table 36. OBSI test results.....	129

ACKNOWLEDGMENTS

The authors wish to thank the Federal Highway Administration (FHWA) and the Ready Mixed Concrete (RMC) Research & Education Foundation for sponsoring this study.

A large number of agencies, organizations, companies, and individuals contributed to the success of the project; their support is gratefully acknowledged and noted below.

The admixtures were supplied by Master Builders, Inc., the Admixture Systems business of BASF's Construction Chemicals division, and the fibers were supplied by Propex. The Bean soybean oil was provided by Jim Miller of C² Products, Inc. XYPEX ADMIX C-1000 and GAMMA CURE products were supplied by the XYPEX Chemical Corporation and Carroll Distributing & Construction Supply, Inc. The cement was donated by Lafarge and the aggregate by Hallett Materials. The deicing chemicals were donated by the Iowa Department of Transportation (DOT).

The authors acknowledge the assistance of R. Christopher Williams of Iowa State University in obtaining the required gyratory compactor background and Tom Brovald of Test Quip, Inc. for assistance modifying the gyratory compactor. Thanks are due to Richard Meininger at Turner-Fairbank Highway Research Center with assistance building our abrasion device. The support of the MnROAD staff—Tom Burnham, Tim Clyne, Jack Herndon, Bernard Izevbekhai, Douglas Lindenfesler, Leonard Palek, and Ben Woral—in constructing, operating, and monitoring the portland cement pervious concrete overlay at MnROAD is greatly appreciated. Heath Cutler conducted the deicing studies and Bin Tong conducted the clogging studies. Laboratory work was assisted by undergraduate students Jeff Bogaards, David Grandfield, and Yang Zhang.

EXECUTIVE SUMMARY

This report presents the results of the largest and most comprehensive study to date on portland cement pervious concrete (PCPC). It is designed to be widely accessible and easily applied by designers, producers, contractors, and owners. Consequently, the chapters are all written as standalone documents and may be read and understood individually. The project was designed to begin with pervious concrete best practices and then to address the unanswered questions in a systematic fashion to allow a successful overlay project. Consequently, the first portion of the integrated project involved a combination of fundamental material property investigations, test method development, and addressing constructability issues before actual construction could take place. The second portion of the project involved actual construction and long-term testing before reporting successes, failures, and lessons learned. The following is a brief summary of notable results from each chapter based on the project tasks.

Pervious Concrete Air Entrainment

Air entrainment is common in traditional concrete and improves durability. Portland cement pervious concrete has a more complicated void system than traditional concrete, containing not only the small-sized entrapped and entrained air in the paste or mortar but also porosity, the larger-sized interconnected void space between the paste-coated aggregate particles. Consequently, questions persisted about the role of air entrainment and its measurement in PCPC. The studies conducted show that the RapidAir test is an effective means of determining the entrained air void structure in PCPC. Air entrainment increased past volume and improved the workability and durability of pervious concrete. It is recommended that air entrainment continue to be used in pervious concrete mixtures.

Measuring Pervious Concrete Workability

Slump is not an effective means to quantify pervious concrete workability. Since pervious concrete for slip form placement is a combination of a self-consolidating concrete and a stiff slip-formable concrete, questions persisted on workability measurement. The current method of forming a ball with the plastic pervious concrete is impossible to specify due to the lack of quantifiable values and individual bias. A new test method based on gyratory compaction was developed to characterize the workability of pervious concrete. The new test method produces consistent concrete specimens, and the output from the test quantifies the workability and compactibility of pervious concrete. Ranges of the workability parameters are suggested that can be used to assist in designing pervious concrete mixtures for specific compaction methods and to allow quantification of placeability for overlay mixture development.

Pervious Concrete Overlay Mixture Development

To ensure good performance during both the construction and service periods, a PCPC mixture for a pavement overlay must possess the following properties:

- High workability for ease of placement
- Uniform porosity or void structure throughout the pavement for noise reduction
- Adequate bond with underlying pavement and proper strength for traffic load
- Sufficient resistance to wearing, aggregate polishing, and freeze-thaw damage

A systematic study using a large number of mix designs was conducted to investigate effects of a wide variety of concrete materials and mixture proportions on PCPC performance, including concrete workability, compaction density, strength, freeze-thaw durability, and overlay bond strength. The results indicate that PCPC mixtures can be designed to be highly workable, sufficiently strong, permeable, and with excellent freeze-thaw durability, suitable for pavement overlays. Such overlays will not only function well structurally for carrying designed traffic loads but also perform well environmentally for noise reduction, skid resistance, and splash and spray.

Pervious Concrete Curing and Surface Durability

Concrete curing is required to maintain sufficient moisture to allow cement hydration and concrete microstructure development, and curing has been shown to impact concrete durability and strength. While many techniques exist to control moisture loss in traditional concrete, most are not appropriate for pervious concrete. Curing is especially important for pervious concrete because the high porosity and bottom exposure of the slab may allow rapid loss of moisture from the fresh concrete due to evaporation. The current method of curing PCPC involves covering the fresh concrete with plastic sheets and allowing the pavement to cure for seven days before removal of the plastic. The effect of nine different curing methods or curing materials was evaluated for effect on pervious concrete properties, including flexural strength and surface abrasion resistance. The samples cured under plastic had the best abrasion and resistance as well as the highest flexural strength, and it was shown that seven days of curing was sufficient for strength gain. Of the other methods, soybean oil has the potential to be an effective curing compound, supplementing or possibly replacing plastic. Additional studying of curing methods will be necessary for large-scale use of pervious concrete in roadway applications and as new products and techniques emerge.

Pervious Concrete Durability to Deicers

In cold weather regions, deicers are applied to a pavement surface to help prevent icing. The relatively-high permeability of PCPC allows melting water to drain into the stormwater system, thus reducing the potential for surface icing due to ponded water. Sand is sometimes applied to pavement in the event that the temperature drops below a level at which deicers can prevent freezing. Because of the nature of PCPC, deicing chemicals cannot be ponded at the top of the sample and will pass through the surface; thus, current methods of evaluation of concrete resistance through immersion of the sample do not accurately reflect typical field conditions. A drained test method was developed to better simulate PCPC field conditions. The drained test

provides improved results compared to the saturated tests and provides a good alternative to simulate deicer damage to pervious concretes. Three deicer solutions were compared with distilled water and samples tested for freeze-thaw durability, surface condition, and compressive strength. Samples without latex polymer had much less mass loss than those using a latex polymer. For a given concrete mixture, sodium chloride or calcium-magnesium acetate performed better than calcium chloride, with less damage.

Design Considerations to Reduce Potential Clogging

Clogging of PCPC leading to potential problems in serviceability has been regarded as one of the primary drawbacks of all permeable pavement systems. A suite of clogging tests was conducted using design porosities of 15%, 20%, and 25% and three sediments: sand, silty clay, and blended sand and silty clay. The fine-grained silty clay had almost no effect on the ability of water to flow through specimens at typical stormwater concentrations. The results with sand and blended materials show that clogging is only an issue at the lowest porosity and primarily for the blended materials. In most cases, sufficient permeability remains after clogging that water flow through the pervious concrete will not be an operational issue for pervious pavements. Several rehabilitation methods were examined. Clogging by sand can best be alleviated using dry vacuuming, while clogging by blended materials can best be alleviated using power washing followed by vacuuming.

Pervious Concrete Overlay Construction

A pervious concrete overlay was constructed on the MnROAD Low Volume Road, a cold region pavement test track near Albertville, Minnesota, in October 2008 over concrete originally placed in July 1993. The PCPC overlay was nominally four inches thick with formed joints approximately over the original skewed joints. The original mix design development work envisioned machine placement of the overlay. Because of weather delays and equipment availability, a powered roller-screed was used for placement. The construction used hand placement of the material, roller screeding, jointing with a mechanical cutter, and curing under plastic for seven days. The construction did leave some surface irregularities in the form of stretch markings and surface sealing.

Pervious Concrete Overlay Field Durability and Performance

Condition surveys of the overlay were conducted in 2009, 2010, and 2011. The primary distress to the overlay pavement was joint deterioration. With a minor amount of cracking, the joint deterioration is believed to be the result of the method of joint placement; saw cutting the joints would have resulted in less deterioration. The joint deterioration increased each year and is likely due to snow plow effects. The flow characteristics have been measured each year, with high infiltration results and good consistency from year to year. Operations during rain events indicate that the pervious overlay quickly removes rainwater from the pavement surface and that the water migrates lateral to the side of the pavement, indicating pervious concrete is a successful tool for mitigating splash and spray as well as reducing hydroplaning difficulties.

Pervious Concrete Overlay Noise Characteristics

Noise measurements have been conducted on the overlay at the MnROAD Low Volume Road and reveal a remarkably quiet pavement. While traditional concrete noise levels range from around 100 to 110 decibels adjusted (dBA), values for the pervious concrete in 2009 and 2010 range between 96 and 98, making the pervious overlay one of the quietest concrete pavements in place.

Summary and Conclusions

The results of the studies conducted show that a pervious concrete overlay can be designed, constructed, operated, and maintained. A pervious concrete overlay has several inherent advantages, including reduced splash and spray and reduced hydroplaning potential, as well as being a very quiet pavement. The good performance of this overlay in a particularly harsh freeze-thaw climate, Minnesota, shows pervious concrete is durable and can be successfully used in freeze-thaw climates with truck traffic and heavy snow plowing.

CHAPTER 1. STUDY OVERVIEW

Introduction to the Study

Portland cement pervious concrete (PCPC) has great potential to reduce roadway noise, improve splash and spray, and improve friction as a surface wearing course. A pervious concrete mix design for a surface wearing course must meet the criteria of adequate strength and durability under site-specific loading and environmental conditions. To date, two key issues that have impeded the use of pervious concrete in the United States are that strengths of pervious concrete have been lower than necessary for required applications and the freeze-thaw durability of pervious concrete has been suspect.

A research project on the freeze-thaw durability of pervious concrete mix designs at Iowa State University (ISU) has recently been completed (Schaefer et al. 2006). The results of this study have shown that a strong, durable pervious concrete mix design that will withstand wet, hard-freeze environments is possible. The strength is achieved through the use of a small amount of fine aggregate (i.e., concrete sand) and/or latex admixture to enhance the particle-to-particle bond in the mix. The preliminary results were reported in Kevern et al. (2005). The recent work has been limited to laboratory testing and to only a few mixes using two sources of aggregates. Preliminary laboratory testing has shown the importance of compaction energy on the properties and performance of the mixes, an issue that has direct bearing on the construction technique used to place the materials in the field. Additional laboratory and field testing is necessary to establish minimum mix design properties and determine optimum construction techniques.

A recent study at Purdue University (Olek et al. 2003) has shown that pervious concrete (termed enhanced porosity concrete in the Purdue University study) can reduce tire-pavement interaction noise. Tests conducted in Purdue University's Tire-Pavement Test Apparatus showed reduced noise levels above 1,000 hertz (Hz) and some increase in noise levels below 1,000 Hz. The increased porosity of pervious concrete increased mechanical excitation and interaction between the tire and pavement at frequencies below about 1,000 Hz and at frequencies above about 1,000 Hz; the air pumping mechanics that dominate at such frequencies are relieved by the increased porosity leading to decreased high-frequency noise levels. Several pervious concrete pavements have been constructed in Europe, and pervious concrete has been shown to be promising in reducing tire-pavement noise and wet weather spray (Descornet et al. 1993; Gerharz 1999).

A recent European Scan (sponsored by the Federal Highway Administration/FHWA) indicated that the use of pervious pavements as friction courses is declining, due to the European preference toward an exposed aggregate concrete. Also, clogging, raveling, and winter maintenance were indicated as problem areas. Participants in the Scan felt that the use of pervious concrete was not given enough time to develop into a viable paving alternative.

The American experience with pervious concrete is limited. It is important to ascertain what material elements can be included in the pervious mix design to address the raveling and clogging issues. If winter maintenance elements and concerns cannot be overcome, pervious concrete may be able to be used in warm weather regions. An extensive research program of

laboratory work and field installations is needed to determine the possibilities for the use of pervious concrete in highway applications.

The National Concrete Pavement Technology Center (National CP Tech Center) at ISU developed a research project titled “An Integrated Study of Portland Cement Pervious Concrete for Wearing Course Applications.” The objective of the research was to conduct a comprehensive study focused on the development of pervious concrete mix designs having adequate strength and durability for wearing course pavements and having surface characteristics that reduce noise and enhance skid resistance while providing adequate removal of water from the pavement surface and structure. A range of mix designs was used necessary to meet requirements for wearing course applications. Further, constructability issues for wearing course sections were addressed to ensure that competitive and economical placement of the pervious concrete can be done in the field. Hence, during the evaluation phases, both laboratory and field testing of the materials and construction were conducted. The focus of the National CP Tech Center’s work on pervious concrete was the development of a durable wearing course that can be used in highway applications for critical noise, splash/spray, skid resistance, and environmental concerns. The comprehensive study is anticipated to be conducted over a five-year period and is further described below.

Background

A recent National CP Tech Center report titled *Mix Design Development for Pervious Concrete in Cold Weather Climates* (Schaefer et al. 2006) provides a summary of the available literature concerning the construction materials, material properties, surface characteristics, pervious pavement design, construction, maintenance, and environmental issues for PCPC. The primary goal of the research conducted was to develop a pervious concrete that would provide freeze-thaw resistance while maintaining adequate strength and permeability for pavement applications. The complete report is available on the Institute for Transportation (InTrans) and National CP Tech Center website at http://www.intrans.iastate.edu/reports/mix_design_pervious.pdf.

The key findings from the literature review can be summarized as follows:

- The engineering properties reported in the literature from the United States indicate a high void ratio, low strength, and limited freeze-thaw test results. It is believed that these reasons have hindered the use of pervious concrete in the hard wet freeze regions (i.e., Midwest and Northeast United States).
- The typical mix design of pervious concrete used in the United States consists of cement, single-sized coarse aggregate (i.e., between one inch and No. 4), and water to cement ratio ranging from 0.27 to 0.43. The 28-day compressive strength of pervious concrete ranges from 800 psi (pound per square inch) to 3,000 psi, with a void ratio ranging from 14% to 31% and a permeability ranging from 36 inch/hour (in./hr) to 864 in./hr.
- The advantages of pervious concrete include improving skid resistance by removing water that creates splash and spray during precipitation events, reducing noise, minimizing heat islands in large cities, preserving native ecosystems, and minimizing

cost in some cases.

- Surface coarse pervious concrete pavement systems have been reported to be used in Europe and Japan.
- Studies have shown that pervious concrete generally produces a quieter than normal concrete with noise levels ranging from 3% to 10% lower than those of normal concrete.

The research conducted at ISU included studies of the materials used in the pervious concrete, the mix proportions and specimen preparation, the resulting strength and permeability, and the effects of freeze-thaw cycling. A variety of aggregate sizes was tested and both limestone aggregates and river run gravels were used. The effects of the addition of sand, latex, and/or silica fume on the resulting behavior were investigated. The key parameters investigated were strength, permeability, and freeze-thaw resistance. The overall results can be summarized in Figure 1, where it can be seen that an interdependent relationship exists between the void ratio, seven-day compressive strength, and permeability of the pervious concrete. In Figure 1 it can be seen that as the void ratio increases, the strength decreases but the permeability increases. Shown in the figure is a target range of void ratio between 15% and 19% in which the strength and permeability are sufficient for the intended purpose. Subsequent freeze-thaw tests showed that a durable mix can be developed, as shown in Figure 2. Key to the development of a mix that would provide sufficient strength, adequate permeability, and freeze-thaw resistance was the addition of a small amount of sand, about 5% to 7%, that increased the bonding of the paste to the aggregates. The laboratory studies also raised the issue of compaction energy on the results. The difference between the compaction energies related to the amplitude of the vibrating pan, while the frequency was constant. Figure 3 shows the results of comparisons of two compaction energies used in the laboratory, and it can be seen that higher compaction energy results in stronger mixes at given void ratios. These results point to the importance of proper compaction in the field.

A number of field sites have also been investigated and the results are reported in the master's thesis by Kevern (2006). Samples from a Sioux City, Iowa site showed more uniform compaction in the top six inches, with low compaction causing high voids and low strength in the bottom layer. A mix proposed for a site in North Liberty, Iowa showed that limestone mixes with unit weight less than 125 pcf (pounds per cubic foot) can be freeze-thaw resistant.

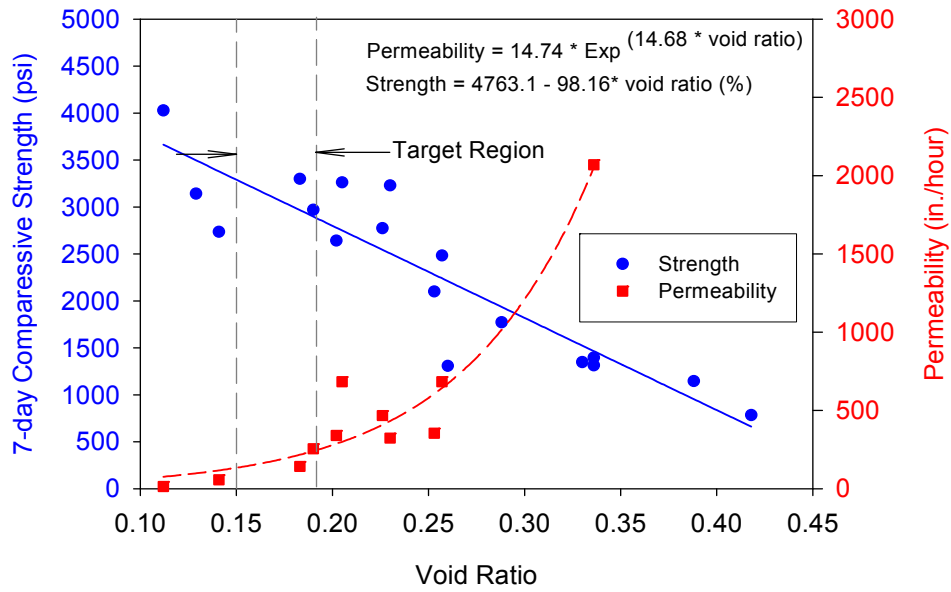

Figure 1. Relationship between pervious concrete void ratio, permeability, and seven-day compressive strength for all mixes placed using regular compaction energy

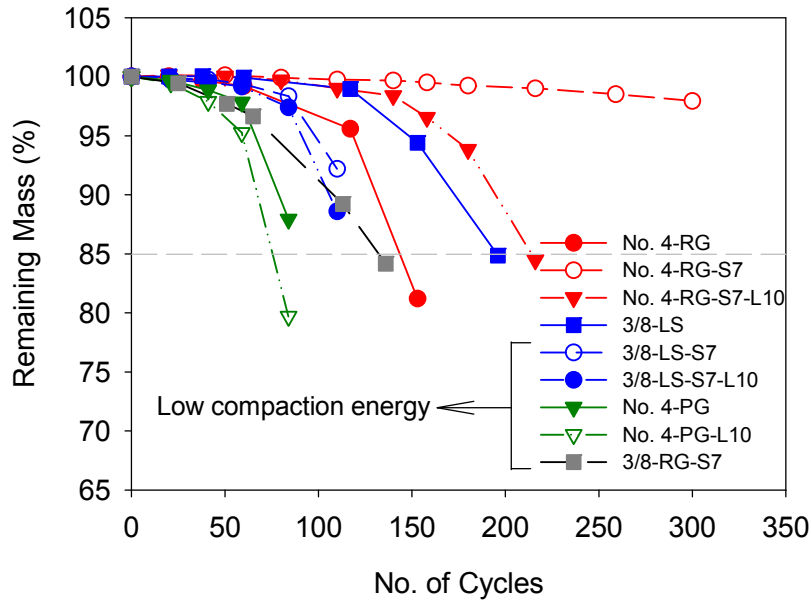

Figure 2. Results of freeze-thaw durability

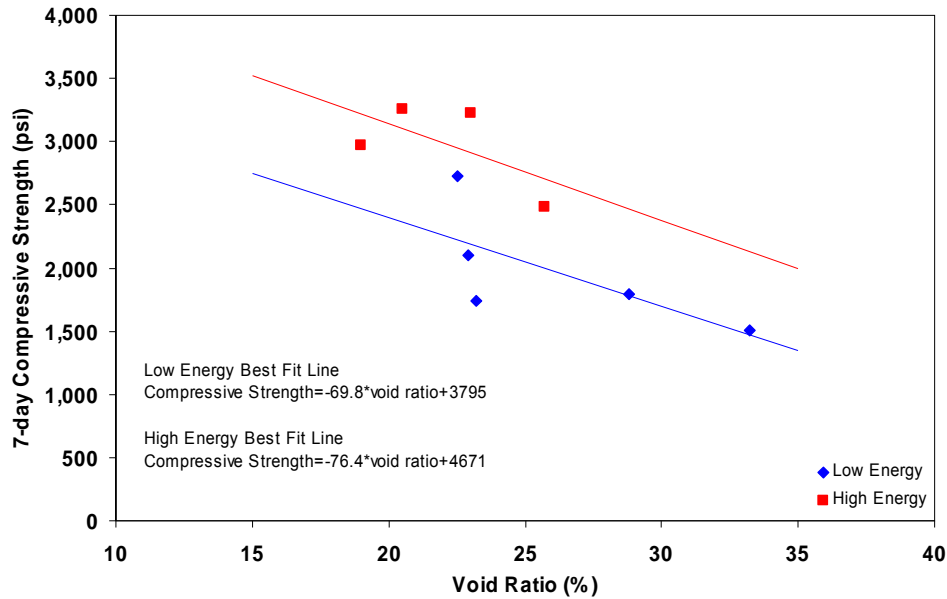

Figure 3. Comparison of results with two compaction energies

The conclusions drawn in the National CP Tech Center study are the following:

- For the three sizes of river gravel (No. 4, 3/8 in., 1/2 in.), larger aggregate size produces concrete mixes with higher void ratio. Pervious concrete mixes made with aggregates of higher abrasion resistance results in higher-strength pervious concrete.
- Using sand and/or latex increases strength and reduces permeability for both aggregate types. Mixes containing only sand had a greater increase in strength than the mixes containing sand and latex. Mixes containing silica fume had higher void ratios and lower strength than the mixes without silica fume.
- Pervious concrete engineering properties vary as a function of void ratio. The compressive strength decreases linearly as the void ratio increases, unit weight decreases linearly as the void ratio increases, and permeability increases exponentially as the void ratio increases, with rapid increase in permeability at void ratios greater than 25%.
- Overall results at regular compaction energy indicate that mixes with void ratios between 15% and 19% produced seven-day compressive strengths ranging from 2,900 psi to 3,300 psi and a permeability ranging from 135 in./hr to 240 in./hr. These mixes had unit weights between 127 pcf to 132 pcf. Furthermore, the splitting tensile strength of pervious concrete was found to be about 12% of the compressive strength.
- Freeze-thaw test results indicate that a mass loss of about 15% represents a terminal serviceability level for a pavement surface. Mixes that contained sand, latex, or both had better freeze-thaw resistance than baseline mixes with single-sized aggregate only. Mixes that contained single-sized aggregate with sand had the best freeze-thaw resistance. Mix No. 4-RG-S7 with air entrainment showed the best freeze-thaw durability with 2% mass loss after 300 cycles.

- Compaction affects pervious concrete properties by reducing compressive strength, split strength, and unit weight, as well as increasing permeability. For example, the average seven-day compressive strength at 22% void ratio is reduced from 2,603 psi to 2,315 psi, which represents an 11% reduction. Split tensile strength is reduced from about 12.3% to about 9.5% of the compressive strength as the compaction energy reduces from regular energy to low energy. However, the average permeability of pervious concrete at a void ratio of 22% increases from 372 in./hr to 614 in./hr, which represents a 65% increase.

The overall conclusion that can be drawn from the recent work at ISU is that well-designed pervious concrete mixes can achieve strength, permeability, and freeze-thaw resistance to allow use in cold weather climates.

Objectives of the Integrated Study

The objectives of the integrated research study include finding optimal pervious concrete mix designs for wearing course sections in pavement applications. Information needed for the wearing course sections must address the issues of noise and skid resistance, assuming adequate strength and durability are developed. The constructability issues are also very critical. It is of paramount importance for the research to determine techniques for construction that utilize existing pavement equipment. At present the construction of pervious concrete sections is quite labor intensive. The use of pervious concrete as a wearing course entails construction of a concrete overlay in rehabilitation efforts. In new construction, two-lift construction is a possibility.

In the integrated study, the scope of research includes the following key tasks:

1. Extension of current laboratory studies will be undertaken to investigate the behavior (strength, porosity, permeability, clogging, and freeze-thaw) of pervious concrete made with various aggregate types and mix proportions used across the United States. These efforts will include determining the basic requirements for aggregate quality, aggregate gradation, admixture types, dosage rates, and concrete mixture proportions to produce the proper strength, porosity, permeability, and freeze-thaw resistance of pervious concrete. As recent work has shown, the importance of compaction energy on pervious concrete results, laboratory studies, and evaluation of placement and compaction techniques for pervious concrete will be undertaken to evaluate the density, porosity, and strength of selected mixes of pervious concrete as a function of compaction effort using gyratory compaction. Comparison placement techniques of vibratory screed and rolling compaction in laboratory-scale model tests will be used to evaluate paving methods to optimize the use of existing paving equipment.
2. Following more extensive mix design studies, evaluation of design thickness requirements for wearing course pervious concrete pavement sections will be undertaken. Initially this will entail laboratory determination and evaluation of noise and skid-resistance properties, as well as laboratory evaluation of thickness and constructability. This will be followed by field trial

sections for the evaluation of in-place pervious concrete properties and for determination of surface characteristics of pervious concrete pavements, including noise and skid-resistance properties.

3. Wearing course applications must involve the development of sufficient bond between the structural layer and the wearing course. Evaluation of the required bond strength and how to develop it will be completed. The evaluation will include wet-on-wet construction as well as wet-on-dry. Durability of the wearing course will be paramount to the success of pervious concrete applications. Use of high-strength cements will be evaluated for effectiveness in addressing durability. The end result will be recommendations for minimum thickness.
4. For wearing course applications, the effect of clogging and maintenance efforts on the material properties of placed concrete will be evaluated. Both laboratory- and field-scale tests are proposed, with splash and spray and freeze-thaw resistance of pervious concrete pavement systems evaluated, again, at both laboratory and field scales.
5. Field trial sections will be placed for evaluation of in-place pervious concrete properties and performance. At the present time, field installations are being considered at the MnROAD low- and high-volume test facilities near Albertville, Minnesota to enable well-instrumented sections to be carefully monitored and also allow noise and splash studies to be conducted. The noise studies will be coordinated with the current Surface Characteristics Study underway at the National CP Tech Center. Field constructability issues will be addressed to develop methods of placement using existing equipment or equipment with appropriate modifications for placement of pervious concrete. Preliminary discussions have been held with one equipment manufacturer to discuss equipment issues. For example, field trials of two-lift construction could be conducted. Field trials could involve single-lift and two-lift construction. The single lift would utilize standard overlay practices and the two lift could examine wet-on-wet construction of the thicker overlays. The field trials will also investigate different curing methods to address the concern of the use of plastic sheeting on large-volume projects.

CHAPTER 2. RESEARCH PLAN

As PCPC progresses from full-depth parking lot type applications to surface wearing course use in the United States, certain obstacles must be overcome to produce a durable surface. Pervious concrete used as a surface course will be subjected to more extreme conditions, and the mix design must be optimized for strength, permeability, and especially better freeze-thaw durability.

The primary concern for surface course pervious concrete is noise reduction and skid resistance. For surface course applications, aggregate size and gradation will need to be adjusted to achieve higher flexural strength, above 500 psi, most likely decreasing permeability. A method for increasing tensile strength and permeability is the use of fibers in the mix. The first ISU study used only one fiber type, and a study needs to be performed to determine the effect of fiber type on the mix in order to optimize the mix design. The high level of exposed surface may make pervious concrete especially susceptible to deicer scaling and could cause premature failure. There is currently no data in the literature about the effect of deicers on pervious concrete. There is also a debate currently on the use of air entraining agents in pervious concrete. The amount of entrained air and the effect of air entrainment on pervious concrete properties and durability need to be investigated. Once the chemical durability of mixes has been established, the mechanical durability and abrasion resistance of pervious concrete for use as a surface course needs to be investigated. To maintain skid resistance and achieve the goals of a permeable pavement, the pavement must maintain its permeability under service conditions. Thus, a clogging test will need to be developed to aid in designing pervious concrete maintenance schedules for optimum performance.

Within the framework of the larger study, the present study is focused on the pervious concrete mix design and overlay thickness design development work necessary to transition from full-depth parking lot applications to surface courses for highway applications. The work outlined below shows the first tasks to be completed in the larger integrated study.

Task 1. Optimize Pervious Concrete Mixtures for Mechanized Placement and Higher Strengths

The mix design will be optimized for aggregate surface area, paste thickness, and fiber addition rate. Aggregate surface area will include three different sizes of pea gravel, each with three sand dilution rates (nine variables). Initially, three paste mixes will be used to determine the paste-to-strength relationship (three variables). Three fiber addition rates will determine if fibers are needed in the lower void ratio mixes and at what addition rate (three variables). Depending upon the variability of the coarse aggregate surface area, four or five surface area combinations will be selected to yield a total of about 50 mixes. The criteria for the modulus of rupture will be greater than 500 psi. The use of fibers will increase the tensile strength, which will allow better overlay performance and possibly thinner pavements. A target minimum permeability of 12 in./hr will be used.

Poor paste-to-aggregate bonding suggests that the condition of the aggregate plays a vital role in the ultimate strength and durability. Testing on mixes with oven-dry, saturated-surface-dry

(SSD), and free surface moisture aggregates will be conducted to determine the effect on the paste-to-aggregate bond. Work to date has shown that a small percentage of sand provides increased strength. In optimizing the pervious concrete mixes for overlay purposes, the role of sand content on strength and permeability will continue to be observed.

Task 2. Evaluate the Effect of Deicing on Pervious Concrete Durability

The best performing mixes will be subjected to potassium chloride, calcium chloride, sodium chloride, sodium acetate, and calcium-magnesium acetate deicers according to ASTM C672. Throughout the test, mass loss and compressive strength will be tested to aid in determining deterioration.

Task 3. Determine the Need for Air Entrainment and the Effect of Air Entrainment on Durability

Currently, there is a division between those who use air entrainment and those who do not in pervious concrete mixes. Other than anecdotal evidence, no serious research has been conducted in this area. Samples with and without an air entraining agent will be subjected to rapid and slow freeze-thaw testing, with and without deicers. Since various air entraining agents produce different air void systems, natural and synthetic air entraining agents will be evaluated. Air void structure will be analyzed using the scanning electron microscope to determine if any air entrainment occurs, and freeze-thaw testing will determine if the air entrainment provided any paste protection. Testing will be conducted to resolve this issue and will include the air void analyzer, air pot, scanning electron microscopy, and RapidAir 457 testing.

Task 4. Workability and Curing Studies

The workability of pervious concrete cannot be measured using a standard slump cone. Pervious concrete that is too dry does not flow out of the truck and increases the difficulty in placement, which affects costs and efficiency. A new test method is needed to allow workability of pervious concrete to be determined in the field where a contractor could test for desired workability and assist in making field additions of water to produce the desired characteristics. At the present time, a workability test based on gyratory compaction appears to be the most appropriate test method. As part of this task, such test development will be pursued through investigating the use of field index tests to correlate to workability as measured with the gyratory test.

For pervious concrete to be used in surface course overlays, field curing without the use of plastic sheets, as is current practice in parking lot applications, must be developed. Various curing methods will be evaluated to determine their effectiveness in preventing drying and the maintenance of a positive curing environment. Samples will be placed and protected with various curing regimes. Once the forms are stripped, the samples will be placed in the ground to simulate field curing conditions and the temperature will be recorded with iButtons and the Iowa State weather station. A baseline mix will be chosen that represents the current state of practice and the surface-applied curing regimes will include the following: none, covered with plastic for

seven days, covered with plastic for 28 days, standard white pigment curing compound, soybean oil curing compound, and an evaporative retardant, Cure, applied to the surface and left uncovered. Additional mixes will include a crystalline waterproofing agent integrally mixed along with an evaporative retardant applied to the surface, a mix containing fly ash replacement for cement, and a mix containing polypropylene fibers.

Task 5. Abrasion Resistance Tests and Test Development

For pervious mixes to be used as a surface course, the issue of raveling and abrasion must be evaluated. Selected mixes from the curing study and deicer study will be tested using the dry rotary cutter standard ASTM C944 abrasion test. A key aspect of field performance will be how well the surface of pervious concrete wearing courses performs when subject to snow blades, and thus, a test that simulates abrasion due to snow blades will be pursued. Calibration of laboratory testing and field wear will be conducted at the Iowa State and MnROAD sites.

Task 6. Clogging and Permeability Test Development

The mixes selected for abrasion resistance will also be subject to clogging tests. At present, no tests have been developed to determine the clogging characteristics of pervious concrete mixes, and thus, test development will be necessary. Currently, permeability is determined on the basis of test methods used for soils. An evaluation and development of appropriate laboratory and field permeability tests particular to pervious concrete is necessary to properly assess the movement of water through the pervious concrete. It is envisioned that a cloggability index (CI) will be developed and correlation between laboratory and field CI values will be made. The CI will help identify the frequency of maintenance required to ensure permeability of the PCPC. In order to determine the CI, the representative elementary volume of pervious concrete must be determined to aid in calibration of laboratory permeability with field testing.

Task 7. Overlay Design Procedures Development

Following the study of the mix design issues, procedures for overlay design will be developed. This effort will be conducted in parallel with current National CP Tech Center efforts to streamline portland concrete overlay designs. Inputs will include surface preparation, thickness design, minimum voids, permeability, tensile strength, and mix proportions. A key issue to be understood in the overlay design is the bond strength that can develop between pervious concrete overlays and both existing and new concrete pavements. Laboratory studies will be undertaken to test bond strength between pervious concrete and portland cement concrete (PCC) to determine required overlay thicknesses.

Task 8. Field Trials

Test sections of pervious overlay will be constructed on the low-volume road area of MnROAD. The mix design will be the one that shows the most promise for bond, raveling resistance, and permeability. The total system behavior will be monitored, including permeability and water

movement, stresses from curling and warping, and strain data produced from specific loading conditions. Regular surface inspection will be used to correlate structural behavior to surface smoothness and durability.

Task 9. Noise Studies

In conjunction with the present Surface Characteristics Study at the National CP Tech Center, noise studies will be conducted on the selected mix designs. The data to be collected include on-board sound intensity (OBSI), in-vehicle, and controlled pass-by noise measurements along with pavement texture determination. These field tests will provide additional data to address the potential for innovative pavements to meet lower noise levels.

Task 10. Preparation of Final Report

The following chapters report on the studies conducted to address Tasks 1 to 9. Conclusions from the studies are presented at the end of each chapter and summarized in Chapter 13. Recommendations for design, construction, operation, and maintenance of PCPC overlays are presented in Chapter 13.

CHAPTER 3. APPROPRIATENESS AND EFFECT OF AIR ENTRAINMENT ON PERVIOUS CONCRETE DURABILITY

Introduction

As PCPC becomes a more popular stormwater management tool, the number of installations in cold climates has increased. It is widely accepted that air entrainment increases the freeze-thaw durability of traditional concrete (Kosmatka et al. 2002). The microscopic air void system can provide spaces in the concrete to accommodate expansive materials, such as water that is expelled from ice formation, thus reducing hydraulic and osmotic pressures. Portland cement pervious concrete has a more complicated void system than traditional concrete, containing not only the small-sized entrapped and entrained air in the paste or mortar but also porosity, the larger-sized interconnected void space between the paste-coated aggregate particles. While air content is a standard property of traditional concrete, no method is currently used to characterize the air voids in pervious concrete.

Because of the large porosity in pervious concrete, commonly used methods of concrete air measurement, such as pressure or volumetric air meters, do not provide useful data for pervious concrete. Although the National Ready Mixed Concrete Association suggests air entraining pervious concrete at a standard dosage rate used to produce concrete curb mixtures, no study has properly assessed whether or not air entrainment is necessary for pervious concrete (Mehta and Monteiro 1993).

The RapidAir system is a relatively new device that automatically determines entrained air properties using ASTM C457 (1998). Sample cross-sections are stained black and then the voids are filled with a white material, such as zinc paste. The contrast allows the device to distinguish between air voids and the hardened matrix of either paste or aggregate. Recent studies have shown that the RapidAir has a high degree of multilab reproducibility and has less variation than the manual technique (Concrete Experts International 2002).

Before mixture development could begin for the PCPC overlay, the role of air entraining agent in pervious concrete durability must be determined. This chapter presents testing and durability results of air structure determination using the RapidAir system. The test results provide insight into whether or not the use of air entraining agents (AEA) in pervious concrete is necessary and if the dosage rates of the AEA used were sufficient to impact durability.

Material Properties and Mixture Proportions

Two types of locally available coarse aggregate were included in the study, crushed limestone and rounded river gravel (pea gravel). The basic properties and gradations of the aggregates are shown in Table 1. The limestone has previously been shown to exhibit poor freeze-thaw durability in the ASTM C666 (2003) procedure A test; therefore, the study of freeze-thaw resistance of the concrete produced with the limestone is not included in the present paper (Jakobsen et al. 2006).

Table 1. Coarse aggregate properties

Property	Aggregate Type	
	Limestone	Pea Gravel
Specific gravity	2.45	2.62
DRUW - kg/m ³ (lb/ft ³)	1,390 (87)	1,640 (102)
Voids in the aggregate (%)	43	37
Absorption (%)	3.9	1.7
Micro deval abrasion (%)	36.4	14.4
Sieve	Percent Passing	
19.0 mm (3/4 in.)	100.0	100.0
12.5 mm (1/2 in.)	99.9	99.8
9.5 mm (3/8 in.)	88.5	99.7
4.75 mm (No. 4)	22.9	21.8
2.36 mm (No. 8)	4.3	1.2

The mixture proportions of the pervious concrete studied are shown in Table 2. The fine aggregate is standard concrete river sand with a specific gravity of 2.62 and a fineness modulus of 2.9. The cement is a Type II, marketed as a Type I/II, with a specific gravity of 3.15 and a Blaine fineness of 384 m²/kg. A polycarboxylate-based high-range water reducer (HRWR) was used for all mixtures. The natural AEA (N) was a vinsol resin type, and the synthetic AEA (S) was olefin based. A total of ten mixtures was studied.

Table 2. Mixture proportions

Mixture	Coarse Aggregate	Fine Aggregate	Cement	w/c	HRWR	Type	AEA
	kg/m ³ (lb/ft ³)	kg/m ³ (lb/ft ³)	kg/m ³ (lb/ft ³)		mL/kg (oz/cwt)		mL/kg (oz/cwt)
Pea gravel (PG)	1,525 (2,570)	80 (130)	345 (580)	0.27	2.75 (4.25)	N, S	0, 1.4, 2.8 (0.0, 2.2, 4.3)
Limestone (LS)	1,425 (2,400)	80 (130)	345 (580)	0.27	2.75 (4.25)	N, S	0, 1.4, 2.8 (0.0, 2.2, 4.3)

Sample Preparation

Concrete was mixed using a rotating-drum mixer by dry-mixing a small amount of cement (about 5%) with the aggregate until the aggregate particles were completely coated (about one minute). Next, two-thirds of the water and the AEA were added and mixed until foam was observed. Then the remaining cement and water (with HRWR) were added. Finally, the concrete was mixed for three minutes, covered and allowed to rest for three minutes, and then mixed for an additional two minutes before casting. All specimens were placed by lightly rodding 25 times in three layers to ensure uniform compaction in each lift. The samples were placed on a vibration table for up to five seconds after rodding each layer. After 24 hours, the samples were demolded and placed in a fog room at 98% relative humidity and cured according to ASTM C192 (2003) (Schaefer et al. 2006).

Cylinder specimens 100 mm (4 in.) in diameter and 200 mm (8 in.) in length were used for RapidAir testing. The top and bottom 50 mm (2 in.) of the hardened concrete cylinders were removed using a concrete slab saw. Two more cuts were then made vertically to produce a specimen with dimensions of 100 mm (4 in.) by 100 mm (4 in.) by 19 mm (0.75 in.). The specimen represents a vertical section taken from the center of the cylinder. The samples were then wet-sanded with progressively finer grit paper, finishing with 6 μm grit.

Samples were treated according to the manufacture's recommendations (Concrete Experts International 2002). The polished samples were coated with a broad-tipped black marker. After the ink had completely dried, the samples were placed into an 80°C oven for two hours. Then the samples were removed and coated with a white paste composed of petroleum jelly and zinc oxide and allowed to cool. The extra paste was removed by dragging an angled razor blade across the surface until all of the paste was removed from the aggregate and cement paste areas. If porous areas of the aggregates contained any white paste, they were individually colored with a fine-tip black marker (Concrete Experts International 2002).

Once a specimen was prepared, the RapidAir device was used to scan across the sample using a video frame width of 748 pixels. Up to ten probe lines per frame can be used to distinguish between the black and white sections. A white-level threshold adjustment further refines the image before air void determination.

Testing Procedures

The porosity of the pervious concrete was determined using Archimedes' principle by taking the difference in weight between oven-dry and saturated submerged specimens using the procedure developed by Montes et al. (2005). The average values of triplicate testing results on 100 mm (4 in.) by 200 mm (8 in.) samples are reported in this paper.

Compressive strength testing was performed according to ASTM C39 (2003). Splitting tensile testing was performed according to ASTM C496 (1996).

The water permeability of the specimens was determined using the falling head permeability test apparatus. A flexible sealing gum was used around the top perimeter of a sample to prevent water leakage along the sides of the sample. The samples were then confined in a latex membrane and sealed in a rubber sleeve that was surrounded by adjustable hose clamps. The test was performed using several water heights that represented values that a pavement may experience (Kevern 2006). The average coefficient of permeability (k) was then determined following Darcy's law and assuming laminar flow. Reported permeability values represent an average of triplicate testing results on 100 mm (4 in.) diameter by 75 mm (3 in.) samples removed from the center of a 100 mm (4 in.) by 200 mm (8 in.) cylinder.

Freeze-thaw resistance was tested using ASTM C666 (2003) procedure A, in which samples were frozen and thawed in the saturated condition.

Values determined from the RapidAir device (Figure 4) are reported according to ASTM C457 (1998). Five traverse lines per frame were used to distinguish between the black sections (aggregate or paste) and the white portions (compacted, entrapped, or entrained air). The threshold values were 120 for the pea gravel mixtures and 104 for the limestone mixtures. Threshold values are not very sensitive to some changes, and ultimately the threshold used for testing is best determined by experience according to specific conditions (Concrete Experts International 2002).



Figure 4. RapidAir device

Results and Discussion

General properties of the concrete studied are shown in Table 3. The unit weight increased from $1,920 \text{ kg/m}^3$ (120 lb/ft^3) to $2,070 \text{ kg/m}^3$ (129 lb/ft^3), and the porosity decreased from 27% to 15% for the pea gravel mixtures having air entrainment from zero to double the recommended dosage. As air entrainment occurs, the volume of paste or mortar increases. The increased volume of paste may reduce the space between the aggregate particles and/or more completely coat the aggregate particles, improving the concrete workability and causing better compaction, thus reducing the porosity and increasing the concrete unit weight. With the increased unit weight and reduced porosity, the compressive strength increased from 16.1 MPa (2,340 psi) to 24.4 MPa (3,530 psi), the splitting tensile increased strength from 1.95 MPa (280 psi) to 2.85 MPa (410 psi), and permeability decreased from 3,492 centimeters (cm)/hr (1,375 in./hr) for the highest porosity sample to 72 cm/hr (28 in./hr) for the lowest porosity sample.

Table 3. Concrete testing results

Mixture	Porosity (%)	Unit Weight kg/m ³ (lb/ft ³)	28-day Compressive	28-day Splitting	Permeability cm/hr (in./hr)
			Strength MPa (psi)	Tensile Strength MPa (psi)	
PG	27.0	1,920 (120)	16.1 (2,340)	1.95 (280)	3,492 (1,375)
PG-N1	23.0	1,980 (124)	23.0 (3,340)	2.30 (340)	1,116 (439)
PG-N2	20.7	1,990 (124)	24.4 (3,530)	2.85 (410)	720 (283)
PG-S1	21.2	2,000 (125)	23.0 (3,340)	2.30 (335)	216 (85)
PG-S2	15.3	2,070 (129)	23.8 (3,450)	2.40 (345)	72 (28)
LS	32.6	1,720 (108)	15.1 (2,190)	1.60 (230)	3,672 (1,446)
LS-N1	31.7	1,710 (107)	13.9 (2,020)	1.40 (205)	2,844 (1,120)
LS-N2	31.1	1,740 (109)	11.3 (1,650)	1.30 (185)	2,664 (1,049)
LS-S1	25.9	1,710 (107)	12.0 (1,740)	1.50 (215)	1,584 (624)
LS-S2	24.7	1,720 (107)	9.6 (1,390)	1.70 (245)	900 (354)

PG=pea gravel, LS=limestone, N=natural AEA, S=synthetic AEA

The unit weight values for the angular crushed limestone mixtures were less variable than the pea gravel mixtures and ranged from 1,710 kg/m³ (107 lb/ft³) to 1,740 kg/m³ (109 lb/ft³). The highest and lowest unit weight values did not coincide with lowest and highest porosity as did the pea gravel mixtures, although the variability in unit weight values was relatively low, 30 kg/m³ (2 lb/ft³). The porosity values ranged from 32.6% for the mixture without air entrainment to 24.7% for the mixture with double dosage synthetic air entrainer. It is possible that for the case of the limestone aggregate, the reduction in porosity occurred primarily because the increased paste volume resulting from the air entrainment filled the voids between the aggregate particles. Permeability ranged from 3,672 cm/hr (1,446 in./hr) for the highest porosity mixture to 900 cm/hr (354 in./hr) for the lowest porosity mixture. The air entrainment produced increased workability/compactibility for both mixtures, but the effect was more pronounced in the pea gravel aggregate.

The following trends can be observed from the concrete testing results (Table 3), which are consistent with previously observed trends (Jakobsen et al. 2006).

- Addition of AEA decreases concrete porosity, thus increasing unit weight.
- As concrete porosity decreases, the concrete unit weight increases, compressive strength and tensile strength increase, while permeability decreases.

The void structure of two limestone samples prepared for RapidAir testing are shown in Figure 5: (a) a sample containing no air entrainment, and (b) a sample containing the highest amount of entrained air produced from the double dosage of the synthetic air entrainer. The boxes represent further magnified areas. It was observed that Figure 5(c), no AEA, appears much darker than Figure 5(d), the paste with entrained air. During sample preparation, zinc paste filled in the entrained air void space resulting in a grayish coloration in the picture of the paste, while the pure white areas are the entrapped air or water-permeable voids (porosity).

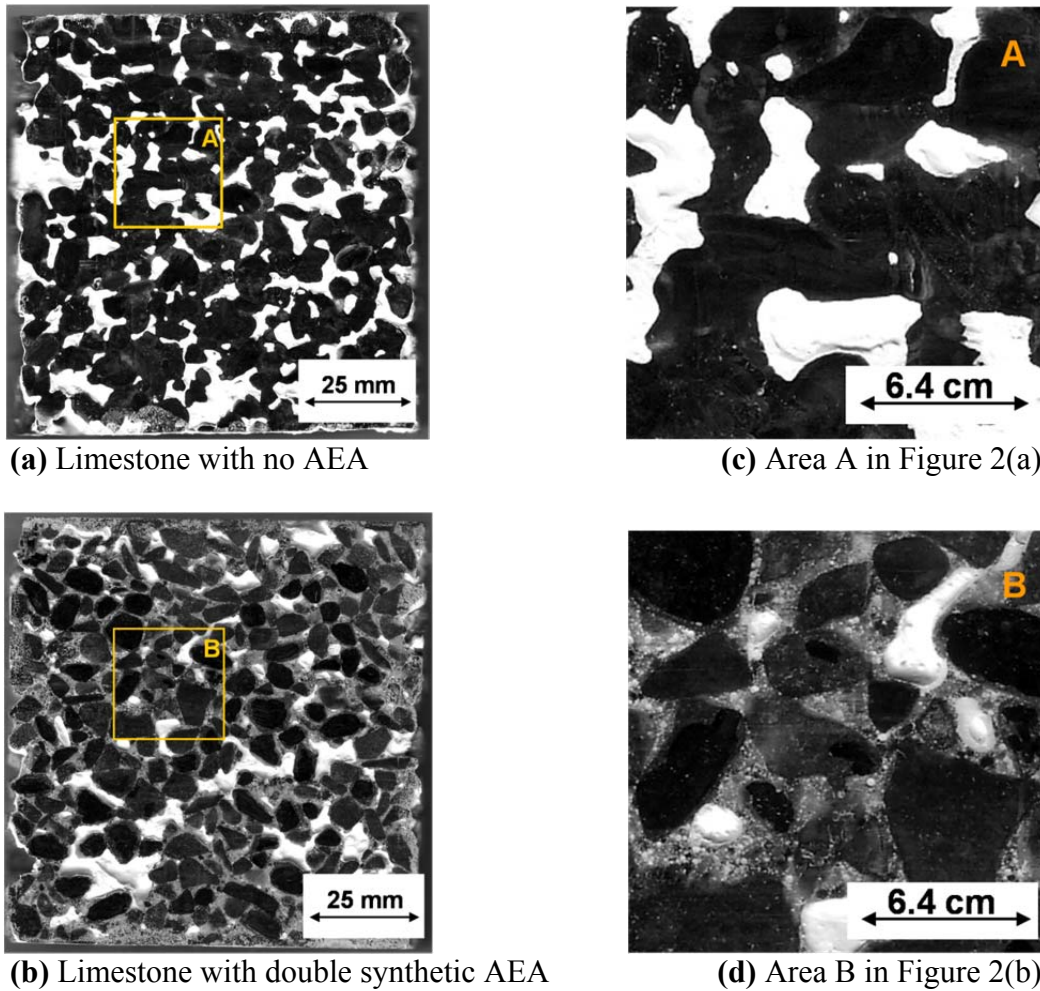

Figure 5. Images of typical pervious concrete samples

In the RapidAir testing, each sample was rotated 90° between trials to determine the consistency of the measurements. Error! Not a valid bookmark self-reference. shows the variation in results produced for the pea gravel mixture with double dosage of the natural AEA. The RapidAir device reports entrained air up to 4 mm in size, so the total air as measured by the RapidAir includes everything 4 mm and smaller (total air <4 mm).

Table 4. Variation of RapidAir tests for a typical sample

PG-N2	Total Air (<4 mm)			Entrained Air (<1 mm)		
	Air (%)	SpF (mm)	SSA (mm ⁻¹)	Air (%)	SpF (mm)	SSA (mm ⁻¹)
1 (0°)	16.53	0.054	22.47	7.04	0.057	50.09
2 (90°)	15.51	0.051	25.39	6.66	0.053	56.80
3 (180°)	15.21	0.050	26.70	8.89	0.051	44.23
4 (270°)	16.15	0.053	23.54	6.76	0.056	53.47
Average	15.85	0.052	24.53	7.34	0.054	51.15
Std dev.	0.60	0.002	1.89	1.05	0.003	5.36

SpF=spacing factor, SSA=specific surface area

The air void characteristics are shown in Table 5. As previously mentioned, for concrete made with rounded pea gravel aggregate, increased air entrainment results in more paste and in increased workability, decreasing porosity. The synthetic AEA at the single dosage produced similar amounts of entrained air as the natural AEA at double dosage. The levels of entrained air in the limestone ranged from 2.3% (without AEA) to 14.4% (with double dosage of synthetic AEA), and the levels of entrained air in the pea gravel mixtures ranged from 2.7% to 8.6%. The air void spacing factor decreased with increased air entrainment. It is generally accepted that a smaller spacing factor produces better freeze-thaw protection of the paste; however, all of the samples tested had values lower than the suggested limit of 0.2 mm (Taylor et al. 2006). A few larger air voids (>1 mm) caused the substantial increase in air volume between that measured as entrained air and the total air at less than 4 mm. The larger voids did not significantly impact the spacing factor, although the average specific surface area decreased.

Table 5. Air void characteristics

Mixture	Porosity (%)	Average of RA Analysis Entrained Air (<1 mm)			Average of RA Analysis Total Air (<4 mm)		
		Air (%)	SpF (mm)	SSA (mm ⁻¹)	Air (%)	SpF (mm)	SSA (mm ⁻¹)
PG	27.0	2.7	0.143	2.75	18.3	0.153	7.31
PG-N1	23.0	6.7	0.065	47.81	18.6	0.062	18.19
PG-N2	20.7	7.3	0.054	51.15	15.9	0.052	24.53
PG-S1	21.2	7.8	0.068	49.58	11.8	0.066	22.30
PG-S2	15.3	8.6	0.055	43.79	16.8	0.052	23.36
LS	32.6	2.3	0.115	52.52	11.7	0.149	11.82
LS-N1	31.7	4.3	0.074	60.76	13.2	0.073	21.46
LS-N2	31.1	6.8	0.047	65.45	18.5	0.045	25.21
LS-S1	25.9	6.7	0.063	48.72	15.6	0.060	22.04
LS-S2	24.7	14.4	0.034	41.84	26.1	0.033	24.20

SpF=spacing factor, SSA=specific surface area

The air content for the pea gravel mixtures is shown in Figure 6 for measured porosity and total air and entrained air measured by the RapidAir device. The porosity decreased with increased level of air entrainment caused by the additional workability added to the cement mortar by the entrained air. The level of entrained air and porosity were similar between PG-N2 and PG-S1. The porosity represents an average of the water-permeable void space measured by the water-displacement method, while the RapidAir values represent the measured air at less than 4 mm. The porosity values were higher than total air for all mixtures except for the highest level of air entrainment (PG-S2), which had a porosity of 15.3% and total RapidAir voids of 16.8%. The difference between the porosity measurement and total RapidAir measurement is 1.5%, which is smaller than the 2.2% variation due to the testing method for the porosity determination (Montes et al. 2005). As more air entrainment occurs, workability increases and the samples become more compacted. The compacted samples generally have smaller pores, thus making more of the porosity void space included in the RapidAir measurements.

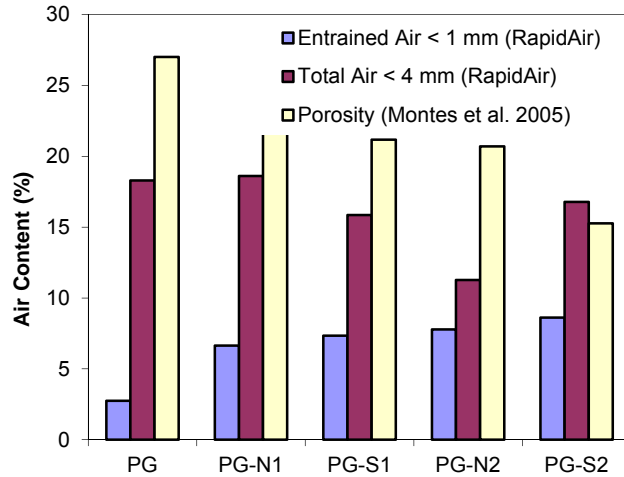

Figure 6. Total air and entrained air for pea gravel aggregate

The air void size distributions for the pea gravel mixtures are shown in Figure 7. The highest occurrence of entrained air was in the range of 0.02 to 0.03 mm. A majority of the entrained air was sized between 0.01 and 0.1 mm. The natural AEA produced higher amounts of the smaller (0.02 to 0.05 mm) voids, while the synthetic AEA produced higher amounts of the medium-sized (0.05 to 0.10 mm) voids. The samples with no AEA had the lowest level of entrained air.

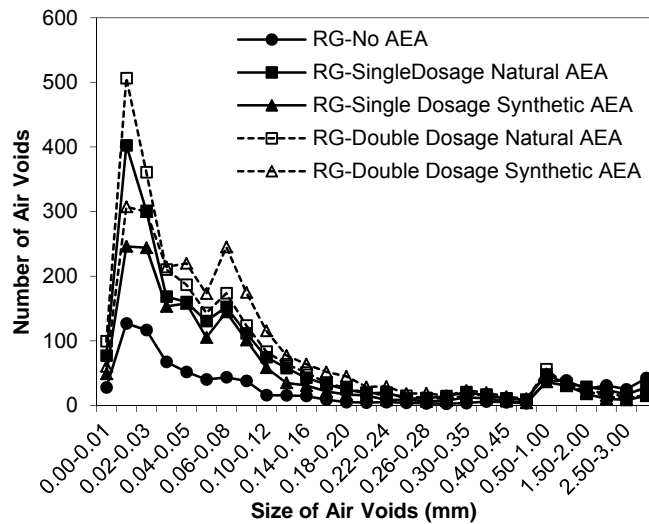

Figure 7. Air void distribution in the pea gravel mixtures

The cumulative distribution of entrained air in the pea gravel mixtures is shown in Figure 8. The delineation between entrained air and porosity can clearly be observed between void size less than 1 mm and those greater than 1 mm. The samples with no air entrainment had the least volume of entrained air. Samples with double dosage of natural AEA (PG-N2) and single dosage of synthetic AEA (PG-S1) had similar levels of air entrainment. The highest dosage of the synthetic AEA had the highest level of entrained air.

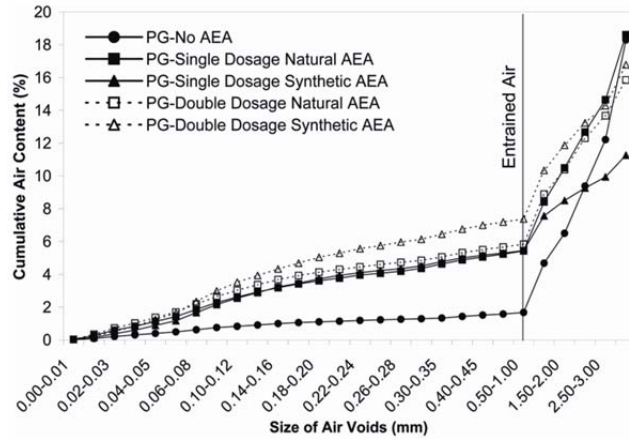

Figure 8. Cumulative air content of pea gravel mixtures

The air contents for the limestone mixtures are shown in Figure 9 for measured porosity, total air, and entrained air determined by the RapidAir device. Differently, for concrete made with the angular limestone aggregate, the total air content measured by the RapidAir system (<4 mm) increased with air entrainment. It is possible that, due to the rough surface texture of the limestone aggregate, the improvement in concrete workability due to the air entrainment might also be less effective than that which occurred in the concrete made with rounded pea gravel. The porosity generally decreased with increased entrained air but not as significantly as the pea gravel, due to the ability of the crushed material to resist compaction through aggregate friction. Similar to the pea gravel mixtures, the porosity was higher than the RapidAir total for all mixtures except that with the highest amount of air entrainment (LS-S2). The testing error of the measured porosity (24.7%) was within that of the RapidAir device (26.1%) for LS-S2.

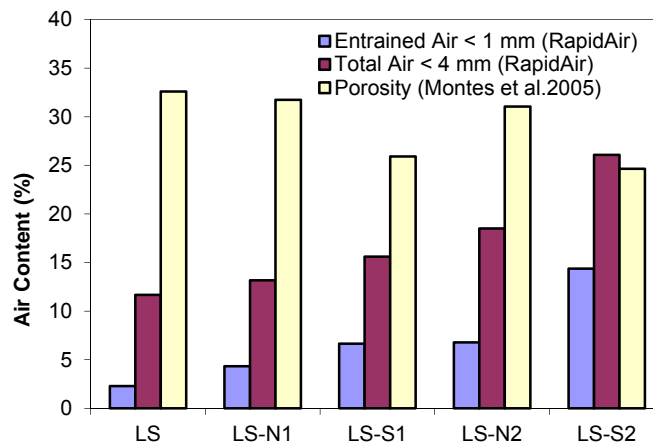

Figure 9. Total air and entrained air for limestone aggregate

The air void size distributions for the limestone mixtures are shown in Figure 10. Significantly higher amounts of air voids were generated at both the double AEA additional levels, particularly in the small (0.01 to 0.03 mm) range. The synthetic AEA had higher amounts of the small voids at the double dosage, and the amounts of small-sized voids were similar at the

recommended dosage rate.

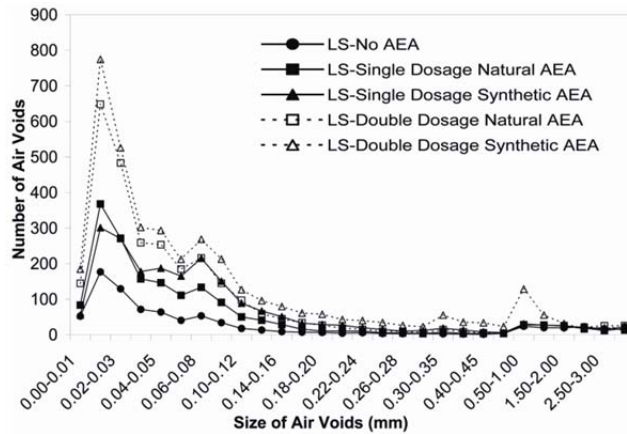

Figure 10. Air void distribution in the limestone mixtures

The cumulative volume of entrained air for the limestone mixtures is shown in Figure 11. The rapid increase in measured air above the 1 mm size again provides segregation between entrained air and porosity. Samples with the double dosage of synthetic AEA (LS-S2) had the highest amount of entrained air, while the lack of AEA (LS) had the lowest amount of entrained air. Similar to the pea gravel mixtures, the single dosage of synthetic AEA (LS-S1) produced a volume of entrained air equal to the higher dosage of the natural AEA (LS-N2).

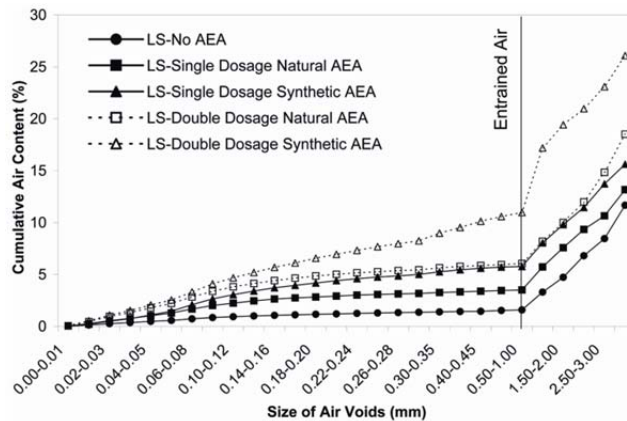

Figure 11. Cumulative air content of limestone mixtures

Freeze-thaw test results for the pea gravel concrete are shown in Figure 12. As mentioned before, the freeze-thaw test results of the limestone concrete are not presented here since the limestone aggregate is not freeze-thaw durable using ASTM C666, procedure A. The pea gravel has been previously shown to be freeze-thaw durable (Kevern et al. 2005). The only mixture that completed the duration of 300 cycles had the greatest amount of entrained air (8.6%), lowest porosity (15.3%), and highest unit weight (2,060 kg/m³), PG-S2. Poorest freeze-thaw durability, failure at 99 cycles, occurred in the mixture without AEA (PG), which had the lowest amount of entrained air (2.7%), highest porosity (27%), and lowest unit weight (1,920 kg/m³). The air

entrainment, porosity, and unit weight were similar between PG-N2 and PG-S1, consequently those mixtures had similar freeze-thaw durability failings at 229 cycles.

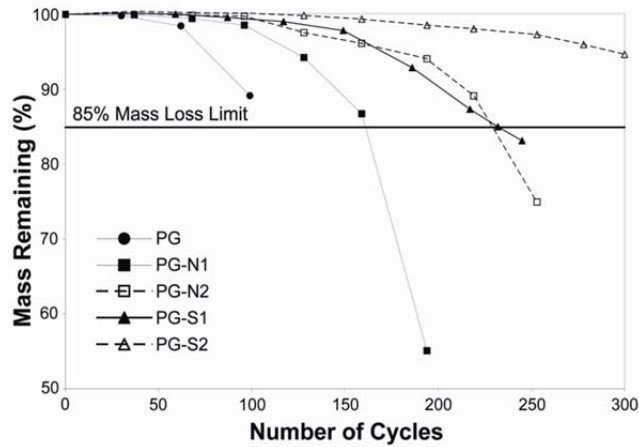

Figure 12. Freeze-thaw durability of the pea gravel mixtures

Conclusions on Air Entrainment

From results presented in this chapter the following conclusions can be made:

- Air entrainment increased the paste volume and improved workability of pervious concrete, thus reducing overall porosity and increasing density. The effect of air entrainment on porosity and workability is more pronounced for concrete made with the rounded aggregate than that in concrete made with the angular aggregate.
- Concrete having lower porosity and consequently higher unit weight displayed higher strength, better freeze-thaw resistance, and lower permeability.
- The RapidAir test results indicated that even without air entrainment, pervious concrete still had spacing factor values less than 0.2 mm (200 μm). This implies that it is the improved density resulting from air entrainment that enhanced freeze-thaw resistance.
- The recommended dosage of synthetic air entrainer produced equivalent contents of entrained air as the double recommended dosage of the natural air entrainer. Synthetic air entrainer produced higher amounts of air entrainment than the natural air entrainer at a given dosage. The entrained air void structure of pervious concrete can be characterized using the RapidAir device.

CHAPTER 4. DEVELOPMENT OF A METHOD TO DETERMINE WORKABILITY

Introduction

Portland cement pervious concrete mixtures that have excellent performance in the lab tend to stiffen during transport, resulting in poor compaction or requiring additional water in the field. Addition of water at the job site increases the water-to-cementitious binder ratio (w/c), decreasing concrete strength and durability. There have been many instances when principles applied from traditional concrete to pervious concrete have resulted in a less-than-optimal final product. To date, determining the workability of pervious concrete has been considered an art form since the conventional slump test does not provide useful information for such stiff concrete. For pervious concrete to achieve consistency in workability and durability required for roadway and the current overlay placement, a better test method was needed. The current method is to evaluate the concrete ability to form a ball with the plastic pervious concrete (Tennis et al. 2004). This method is impossible to specify because of the lack of quantifiable values and individual bias. A more scientific method of workability determination is required if PCPC is to progress to large-scale parking areas and surface overlays.

Pervious concrete is designed to transport stormwater into the underlying layers through a series of interconnected voids, while providing the designed load-carrying capacity. The interconnected voids are produced from a balance between aggregate gradation and binder content. In the concrete mixture design, the objective is to provide a sufficient amount of voids to infiltrate the design stormwater intensity. There is a direct relationship between voids and compressive strength, where lower void contents produce more intraparticle contact and consequently higher load-carrying capacities (Schaefer et al. 2006). The void content of the plastic and hardened pervious concrete can be determined from the unit weight. Determination of plastic workability becomes increasingly important since the required parameters (permeability and strength) are based on unit weight, which is achieved through proper placement. A highly workable mixture requires less compaction energy to achieve higher unit weight than a stiffer mixture. By quantifying pervious concrete workability, mixtures can be designed to produce certain void contents using specified compaction methods and the workability can be verified and adjusted accordingly before placement.

This chapter describes a portion of the study where a superpave gyratory compactor (SGC) was modified to develop a test method to characterize the workability of pervious concrete. In this procedure, pervious concrete samples were produced using an SGC that allows for simulating various field compaction conditions. Workability of the concrete is then defined by the density versus gyration relationship. A matrix of concrete mixtures that consists of various w/c and cement contents is tested. The effect of mixing time on concrete workability is also evaluated so as to identify “slump loss” of field pervious concrete. The results show the SGC is able to produce consistent pervious concrete specimens, and the output of the test method well quantifies the workability and compactibility of the plastic concrete. The discussion includes a range of suggested values to allow design and verification of production pervious concrete workability.

Gyratory Test Method Development

Device Modification

It is well understood that gyratory compactors sufficiently simulate the type of compaction utilized by the asphalt industry, primarily steel drum and pneumatic compaction (AI 2001). Since pervious concrete is loosely placed and then finished/compacted with either a weighted drum or roller-screed, the use of a gyratory compactor is appropriate to simulate field conditions. Normal conditions for a Superpave asphalt design require a 600 kPa (87 psi) pressure for laboratory compaction to simulate field compaction (AI 2001). For this study, a gyratory compactor was modified to achieve a compactive effort of 60 kPa (8.7 psi), within a tolerance of 2 kPa (0.3 psi), for 150 mm (6 in.) diameter samples. The AFGB1 gyratory compactor used in this study is among the cheapest and most portable devices available to the asphalt industry and is a commonly used piece of equipment both for laboratory mixture development and field quality control/quality assurance activities. Modification of the device to achieve the 60 kPa (8.7 psi) pressure requires only removing a high-pressure hydraulic orifice and does not impact the machine's ability to maintain the standard 600 kPa (87 psi). Further modification to achieve pressures lower than 60 kPa (8.7 psi) limits the device to only the lower pressures. Consequently, the easily achievable 60 kPa (8.7 psi) was selected as the lowest practical testing pressure.

Determination of the Maximum Number of Gyration

Previous research using gyratory compaction on roller-compacted concrete has shown that 100 gyrations is sufficient to obtain uniform and complete compaction (Amer et al. 2003). Figure 13 shows a typical compaction/density-gyration curve of pervious samples compacted at the 60 kPa pressure, and Figure 14 shows the height difference of the samples compacted at 20, 50, and 100 gyrations. At 100 gyrations, the change in slope of the compaction curve is small, nearing the maximum asymptote. Consequently, 100 gyrations was selected as the upper limit for compaction of the pervious specimens.

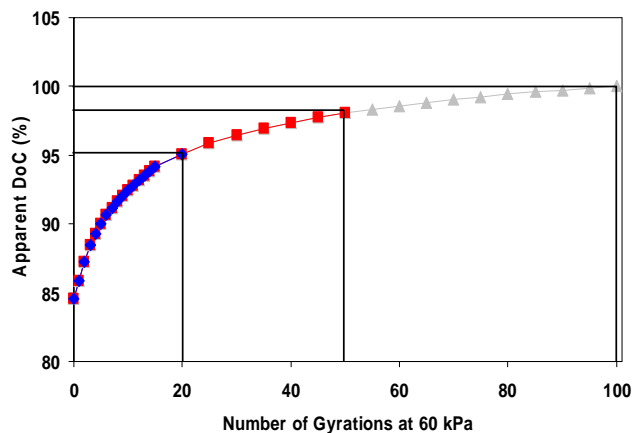

Figure 13. Typical compaction density curve

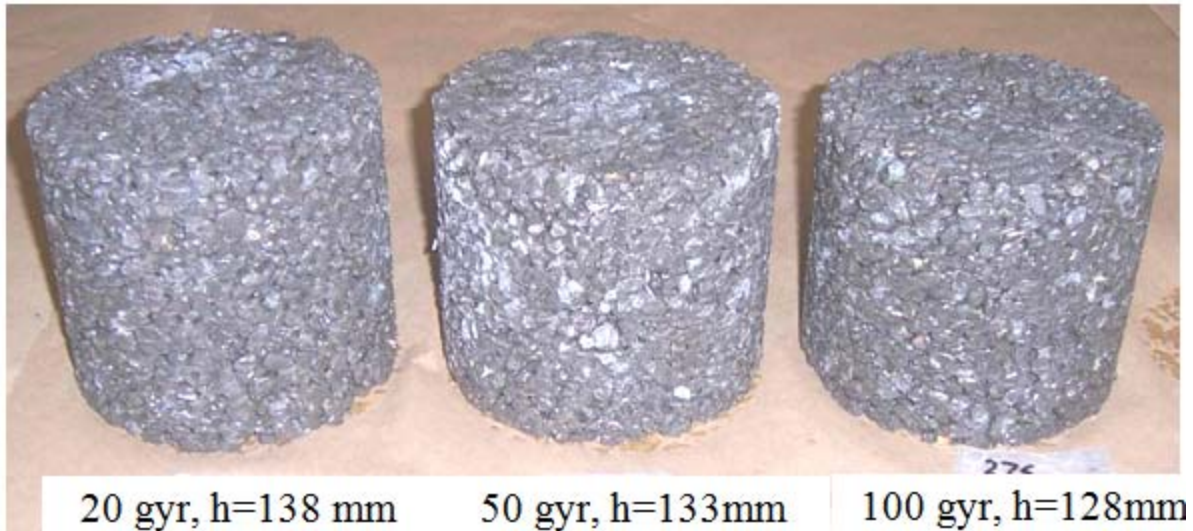

Figure 14. Samples compacted at different gyrations (gyr)

In order to determine the pressure required to produce a design void content (DVC) of 20% at 100 gyrations, the baseline mixture (Mixture #4, Table 6) was compacted in 150 mm (6 in.) diameter molds using 60 kPa (8.7 psi), 120 kPa (17.4 psi), 180 kPa (26.1 psi), and 240 kPa (34.8 psi). The ratio of the unit weight at N gyrations to the unit weight at DVC is defined as the apparent degree of compaction (DoC). Results in Table 7 show that 60 kPa (8.7 psi) produced compaction closest to the DVC with DoC increasing with compaction pressure.

Table 6. Mixture proportions

Material	Mixture #, kg/m ³ , (pcy), [%]								
	M1	M2	M3	M4*	M5	M6	M7	M9	M10
River gravel	1820, (3060), [69.3]	1700, (2869), [65.0]	1620, (2732), [61.9]	1580, (2669), [60.5]	1550, (2608), [59.1]	1510, (2550), [57.8]	1600, (2690), [61.0]	1570, (2647), [60.0]	1560, (2625), [59.5]
Type I/II Cement	180, (306), [5.8]	260, (430), [8.1]	310, (519), [9.8]	330, (560), [10.5]	360, (600), [11.3]	380, (638), [12.0]	340, (565), [10.6]	330, (556), [10.5]	330, (551), [10.4]
Water	50, (83), [4.9]	70, (116), [6.9]	80, (140), [8.3]	90, (151), [9.0]	100, (162), [9.6]	100, (172), [10.2]	80, (141), [8.4]	100, (161), [9.5]	100, (171), [10.1]
DVC	20%	20%	20%	20%	20%	20%	20%	20%	20%
b/a	0.10	0.15	0.19	0.21	0.23	0.25	0.21	0.21	0.21
w/c	0.27	0.27	0.27	0.27	0.27	0.27	0.25	0.29	0.31

Table 7. Degree of compaction versus different compaction pressures

Gyratory Pressure	DoC (%)	Voids (%)
60 kPa (8.7 psi)	100.2	19.8
120 kPa (17.4 psi)	100.5	19.6
180 kPa (26.1 psi)	101.3	19.0
240 kPa (34.8 psi)	101.6	18.7

Characterization of Workability Using the Gyratory Compaction Curve

The compaction curve produced by the SGC (see Figure 13) has two distinct portions: (1) the first portion characterized by a steep slope where excess air voids are removed under the initial, short-term compaction; and (2) the second portion characterized by a smaller change in slope as particle rearrangement occurs. The first portion depends primarily on intrinsic workability of a particular mixture or the self-compacting ability. The second portion is controlled by the resistance of a particular mixture to additional compaction energy. Since the goal of pervious concrete placement is to reach an in-situ DVC and unit weight, the same outcome can be achieved either by a highly workable mixture or by applying additional compaction energy. A very fluid mixture design may require little to no compaction after discharge, but a stiffer mixture may require compaction with a weighted roller. Both methods may result in the same void content, although achieved by two different mechanisms, requiring the consideration of both components of the compaction curve.

In the asphalt industry, the initial compaction level is calculated between six and eight gyrations, depending on the design traffic level (Stakston and Bahia 2003). Maximum curvature occurs at the point where the slope of the second derivative goes to zero and was used to define the boundary between workability and compactibility. Maximum curvature occurred between seven and nine gyrations with the most occurring at eight gyrations, when determined for the range of project mixtures (Table 8). For pervious concrete specimens, the compaction at eight gyrations is slightly greater than 90% of DVC. Consequently, eight gyrations was selected to define initial workability for pervious concrete.

Table 8. Determination of maximum curvature

b/a	w/c	Point of Maximum Curvature
21	0.25	8
21	0.27	8
21	0.29	8
21	0.31	7
<hr/>		
10	0.27	8
15	0.27	8
19	0.27	9
21	0.27	8
23	0.27	8
25	0.27	9
<hr/>		
	avg	8.10
	std dev	0.57

b/a=binder-to-aggregate ratio (by dry mass)

The unit weight and DoC at zero gyrations were observed to have a large degree of variability resulting from the placement of the samples in the gyratory mold. Beginning after the first gyration, the compaction curve was mixture controlled. In order to eliminate the variability caused by sample placement in the mold, workability was defined after the first gyration. The area under the compaction curve from one to eight gyrations is termed by the workability energy index (WEI) and defines the inherent workability from little additional compaction, as shown in Figure 15. The final portion of the curve, representing compactibility, is defined as the area under the compaction curve from eight gyrations to the DVC or 100 gyrations, whichever occurs first, and the DoC achieved at eight gyrations. This value is termed the compaction densification index (CDI) and represents the practical amount of additional energy required to bring the mixture to the DVC, as shown in Figure 15. The combination of WEI and CDI is termed the placeability of a pervious concrete mixture.

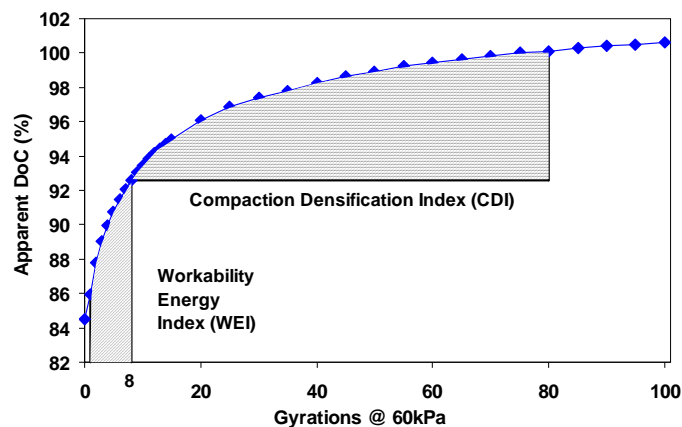

Figure 15. Definition of workability index parameters

Mixture Proportioning and Processing

A simple baseline pervious mixture (Mixture 4, Table 6) was selected to determine if the SGC's lowest possible pressure of 60 kPa (8.7 psi) was capable to produce the DVC. The DVC can be determined by calculating the volume of air remaining after the solid fractions have been accounted for according to the volumetric mixture proportions. This method will generally produce pervious concrete as the aggregate gradation contains at least 35% initial voids (Kevern et al. 2008a). The baseline mixture contained single-sized 4.75 mm (No. 4) river gravel, Type I-II Portland cement, and a water-to-cement ratio of 0.27. All mixtures contained a polycarboxylate type mid-range water-reducing admixture dosed at 4 mL/kg cement (6 oz/cwt). Using the mixture proportions shown in Table 6, the DVC was determined as 20% at 1990 kg/m³ (124.5 pcf). While permeability data is not presented in the current study, mixtures that possess 20% voids have the required permeability for pervious concrete of greater than 30 cm/hr (12 in./hr) (Schaefer et al. 2006).

All mixtures were batched with the aggregate in the saturated-surface dry state (SSD) to prevent changes in water content during mixing that may impact workability values. Concrete was mixed in a 0.10 m³ (3.0 cf) rotating drum mixer. Aggregate, cement, and two-thirds water were added and mixed until uniform, about 30 seconds. Then the remaining water with the water reducer was added and mixed for three minutes, rested for three minutes, and mixed for an additional two minutes, according to ASTM C192 (2003). Additional information regarding mixture development and mechanical properties was presented by Kevern et al. (2008b).

Test Results

General Properties of the Pervious Concrete Specimens

The relationship between unit weight and void ratio for pervious concrete is well understood (Kevern 2006; Meininger 1988; Neithalath et al. 2003; Schaefer et al. 2006.). The SGC procedure has the ability to provide plastic workability properties through the compaction output curve, in addition to producing unbiased hardened samples that may be used for quality control purposes. Samples produced using the baseline mixture, while determining appropriate pressure and number of gyrations, were tested for hardened unit weight, voids, and splitting tensile strength (f_{sc}') at seven days according to ASTM C496 (2003). Voids were tested according to the procedure developed by Montes et al. (2005). Plastic unit weight was determined from the SGC compaction curve and then used to calculate plastic void content. The properties of samples produced from the baseline mixture are shown in Table 9. The void ratios ranged from 19% to 30%, with up to a 6% difference between the plastic voids and those determined from oven-dry samples.

Table 9. Gyrotory-compacted sample properties (baseline mixture)

Gyration s	Pressure kPa (psi)	Measured Plastic Unit Weight	Calculated Plastic Voids	Measured Oven- Dry Unit Weight	Measured Oven- Dry Voids	Seven- day f_{sc}'
		kg/m ³ (pcf)	(%)	kg/m ³ (pcf)	(%)	kPa(psi)
100	60(8.7)	1996(124.6)	19.9	1937(120.9)	25.1	1785(259)
100	120(17.4)	2019(126.0)	19.0	1937(120.9)	25.1	1826(265)
100	180(26.1)	2007(125.3)	19.5	1958(122.2)	21.3	1895(275)
100	240(34.8)	2027(126.5)	18.7	1966(122.7)	23.9	1743(253)
4	60(8.7)	1745(108.9)	30.0	1692(105.6)	36.5	992(144)
20	60(8.7)	1879(117.3)	24.6	1833(114.4)	29.9	1171(170)
25	60(8.7)	1868(116.6)	25.1	1804(112.6)	31.2	1357(197)
50	60(8.7)	1943(121.3)	22.0	1897(118.4)	26.3	1867(271)
150	60(8.7)	1985(123.9)	20.4	1942(121.2)	24.5	1488(216)

The relationship between voids and unit weight is shown in Figure 16 for both the plastic values calculated from the SGC and the measured oven-dry values. As previously observed, the reduction in unit weight with increased voids is linear for samples of different compaction levels produced from the same mixture (Suleiman et al. 2006). The plastic unit weight was always higher, corresponding in lower voids, than that of the same samples tested in the oven-dry state. The difference between calculated and measured voids decreased with increased compaction level.

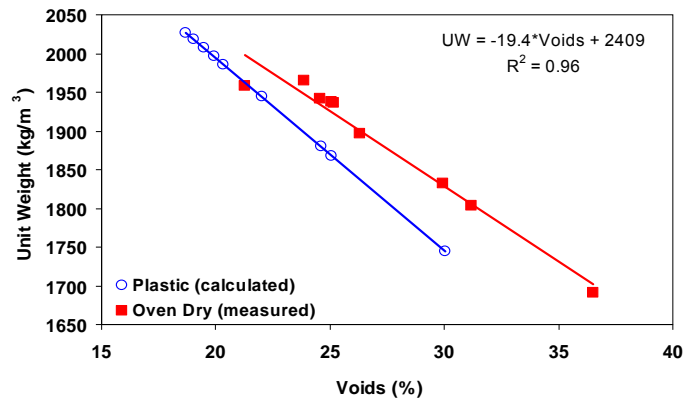

Figure 16. Relationship between voids and unit weight of pervious concrete samples made with gyrotory compaction

The relationship between splitting tensile strength and compressive strength for pervious concrete is between 12% and 15% of the compressive strength (Schaefer et al. 2006). Since the determination of splitting tensile strength allows for any diameter and length specimen, splitting tensile strength was selected to report strength. The samples were tested at seven days, and the relationship between voids and tensile strength is shown in Figure 17. The trendline has an R^2 of 0.77 with the expected outcome of lower strength with increased voids.

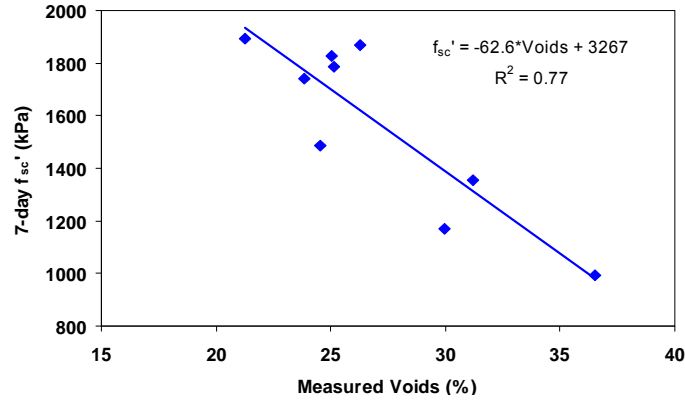

Figure 17. Relationship between voids and splitting tensile strength

Factors That Influence Pervious Concrete Workability

The key factors in pervious concrete mixture design that influence workability are the aggregate angularity; b/a ratio, the weight of the cementitious materials divided by the weight of the oven-dry aggregate; and w/c binder ratio, the weight of the water divided by the weight of the cementitious materials. In addition to the basic mixture design components, admixtures are often used to enhance workability and to extend the placing window. The mixture proportions used to evaluate gyratory workability all had a DVC of 20% and aggregate, cementitious materials, and water contents were adjusted accordingly. To evaluate the validity of the WEI and CDI indices, a variety of common pervious concrete mixture proportions were tested: b/a = 10, 19, 21, 23, and 25; w/c = 0.25, 0.27, 0.29, and 0.31; workability at 10-minute, 30-minute, and 60-minute mixing times.

Effect of Binder-to-Aggregate Ratio

Pervious concrete cement paste/mortar connects the aggregate pieces and transfers load throughout the pavement. Too little cement paste provides insufficient connected area for the required concrete strength and durability. On the other hand, too much paste fills in the concrete voids and does not allow the required permeability. The effect of the b/a on workability was evaluated using a mixture with a fixed w/c of 0.27. Table 10 provides the average workability and compactibility results for the various b/a ratios.

Table 10. Gyratory results for pervious concrete with different binder-to-aggregate ratios

w/c	b/a (%)	WEI	CDI
0.27	10	599	482
	15	618	492
	19	656	56
	21	662	24
	23	665	27
	25	696	0

Figure 18 shows the relationship between workability (Figure 18a), compactibility (Figure 18b), and b/a. Each point in the figure represents the average of three tests. The workability (WEI) increased linearly with increased b/a and additional required compaction energy (CDI) decreased with increased b/a. In pervious concrete, sufficiently wetted cementitious paste provides lubrication between the aggregate particles. While the workability continued to increase with increased b/a, there was a sudden drop in required compaction energy when enough cement paste was present to provide particle separation, between a b/a of 15% and 19%.

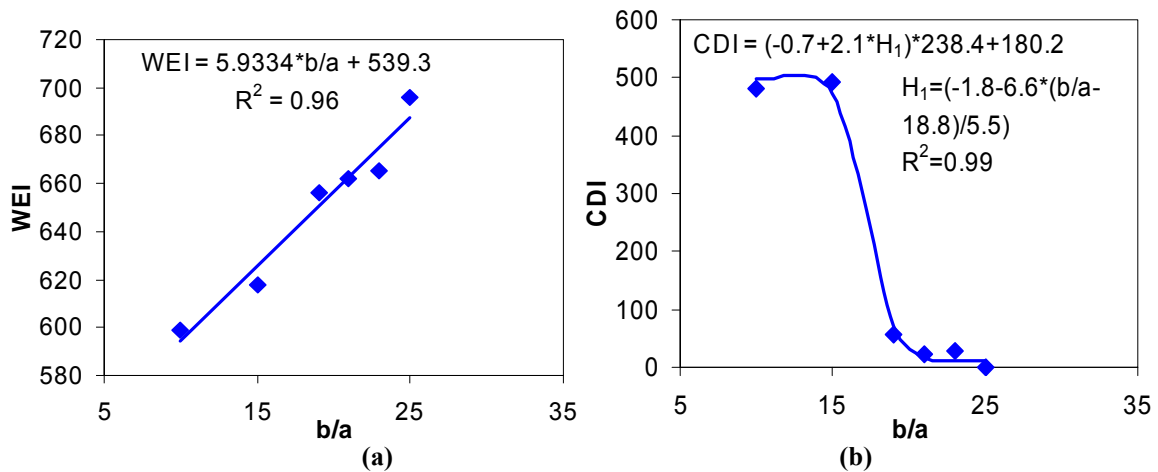

Figure 18. Effect of binder-to-aggregate ratio on placeability index parameters

The workability of the samples with b/a of 15% (WEI = 618) was similar to the stiffer mixtures commonly observed in the field. Any mixture having a further decrease in workability (WEI <600) would require remediation or rejection of the mixture. Once the b/a increased to 19% (WEI = 656), the workability had improved to a point where the mixture achieved DVC easily, and especially for a b/a of 25% (WEI = 696), which may be considered self-consolidating. The impact of increased b/a on compactibility was even more pronounced than WEI. The lower b/a mixtures, a b/a of 10% (CDI = 482) and 15% (CDI = 492), resisted compaction and required substantial compaction energy to achieve DVC. Again, once the b/a increased to 19% (CDI = 56), the required compaction energy decreased and, further, at a b/a of 25% no additional energy was required. The results suggest that a minimum WEI of 600 and CDI of 450 may be appropriate for pervious concrete to have acceptable workability.

Effect of Water-to-Cement Ratio

When pervious concrete arrives at a job site, the workability is “evaluated” and if it is too dry, up to a half gallon of water per cubic yard of concrete is added at a time to improve workability (NRMCA 2005). It is understood that more water generally improves workability in either traditional or pervious concrete, but it reduces overall performance (Kosmatka et al. 2002). Pervious concrete is produced in a very small window of w/c (approximately 0.27–0.33). When too dry, the paste does not have enough cohesion to coat and join the aggregate particles together, while, when too wet, the paste drains away from the aggregate and clogs the water-carrying pores. The effect of w/c on the narrow range used for pervious concrete is shown in

Figure 19 and values presented in Table 11. Each point in the figure represents the average of three tests. The workability (WEI) generally increased with increased w/c, although the slight reduction in WEI at w/c of 0.31 could be a result of the lower viscosity of the cement paste allowing more aggregate-to-aggregate friction. For this particular aggregate and b/a combination, w/c values above 0.31 caused draining of the cement paste from the aggregate surfaces. Required compaction energy (CDI) also generally decreased with increased w/c, with a large decrease in CDI between a w/c of 0.25 to 0.27. Similar to the compactability trend shown in the previous figure, a significant drop in required compaction energy occurred when the paste became sufficiently wetted and began lubricating the aggregate particles, between w/c of 0.25 and 0.27.

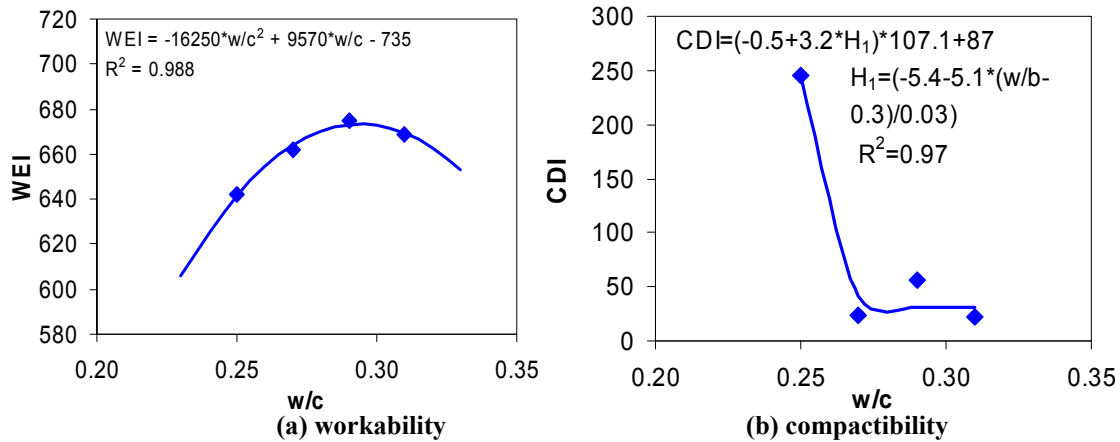

Figure 19. Effect of w/c on workability and compactibility

Table 11. Gyrotory results for pervious concrete with different w/c ratios

b/a	w/c	WEI	CDI
0.21	0.25	642	246
	0.27	662	24
	0.29	675	56
	0.31	669	22

Since the mixtures were placed with typical w/c contents, the measured workability was high (WEI >600). The compactibility for all mixtures was less than CDI = 450 and typical for pervious concrete mixtures in the field, although the w/c = 0.25 was significantly higher than the other tests. Comparing the effect on workability of b/a and w/c, the WEI is influenced more significantly by binder content than by w/c. Workability increased with either increased binder or w/c, but the required compaction energy dropped significantly when enough paste (cement and water) was present.

Effect of Mixing Time

The large amount of exposed surface area makes pervious concrete especially susceptible to “slump loss” with time, either from moisture evaporation or limited admixture working time. The effect of mixing time on placeability of pervious concrete has not been previously studied.

Typical specifications allow concrete to be placed up to 90 minutes after batching or 150 revolutions in the ready mix truck (ASTM C94 2003). Highly workable pervious concrete mixtures produced in the lab are rarely so in actual production. To evaluate the effect of mixing time on pervious concrete placeability, mixtures were subjected to more realistic mixing times. Figure 20 shows the decrease in workability caused by additional mixing time for Mixture #3. T=1 represents workability immediately after initial mixing (about 10 minutes total time), T=2 after resting during initial gyratory testing and 15 minutes of additional mixing (about 30 minutes total time), and T=3 after additional resting during T=2 testing and another 15 minutes of mixing (about one hour total time). As mixing time increased, the apparent degree of compaction at any given gyration was lower than the previous time period, indicating stiffening of the pervious concrete mixture. However, the initial slope is similar for a particular mixture observed at different mixing times.

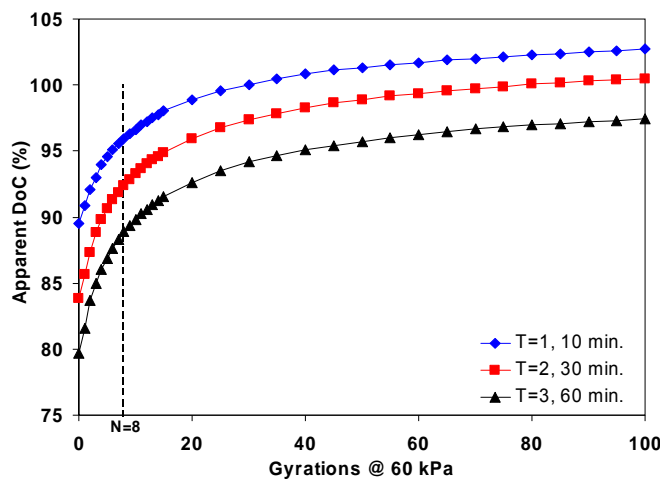

Figure 20. Effect on workability with increased mixing time

The large difference in workability and compactibility over time makes consistent placement of pervious concrete using a fixed compaction method difficult. A certain compaction and finishing method that produces DVC at T=1 will result in unacceptably high voids and low unit weight if applied to the same mixture at T=3. The effect on compactibility caused by mixing time was similar for all mixtures tested in either of the previous two phases. The effects on placeability of the maximum and minimum b/a and w/c mixtures are shown in Figure 21. A relatively uniform decrease in workability occurred with increased mixing time. Required compaction energy increased regularly with mixing time for different binder contents with fixed water content. At a lowest w/c of 0.25 and fixed b/a of 0.21, the CDI increased between Time=1 and Time=2 but leveled off after Time=2. At the highest w/c of 0.31, compactibility remained low (CDI <100) for the first two time periods but substantially increased at Time=3, and at the later time there was no difference in compactibility between the lowest and highest w/c samples. At one hour of total time (T=3), it was observed that most mixtures had passed a placeability window and would be subject to rejection. The paste had lost the required metallic sheen (NRMCA 2005) and had started forming paste balls and leaving bare aggregate.

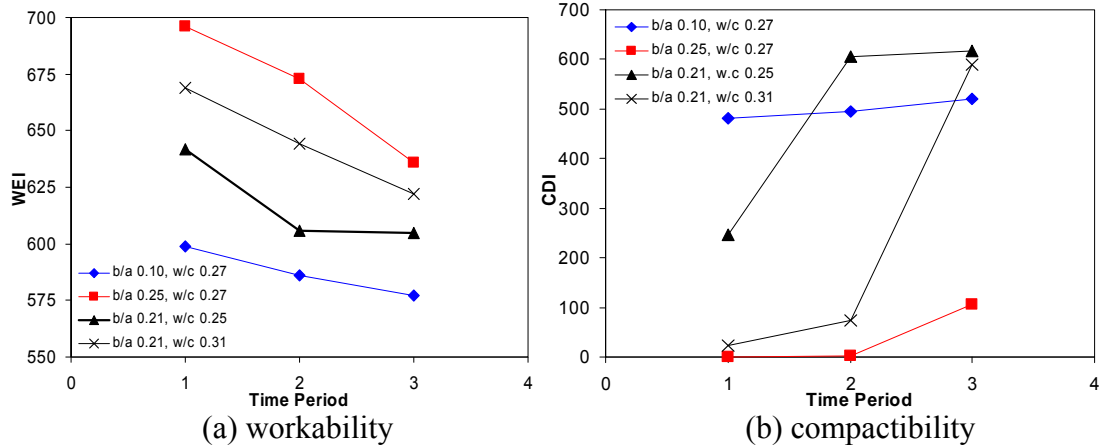

Figure 21. Effect on placeability of mixing time

The common reaction to improve placeability of pervious concrete is to increase the water content. Increased water content provides greater workability for all time periods, although it does not provide increased compactibility at later times. To increase placeability at later ages, it is more beneficial to increase the binder content than the water content.

Classification of Pervious Concrete Placeability

The identification of desired placeability parameters will allow pervious concrete mixtures to be better designed, taking into account compaction energy versus desired voids, and allow better quality control in the field. From this study, guidelines for workability and compactibility are developed and presented in Table 12. Following the guidelines, mixtures can be designed and required to meet placeability requirements, increasing the consistency and quality of pervious concrete placements.

Table 12. Ranges of pervious concrete gyratory values

Workability (WEI)	
Behavior	Range
Highly workable	>640
Acceptable workability	640>WEI>600
Poor workability	WEI<600
Compactibility (CDI)	
Explanation	Range
Self-consolidating	CDI<50
Normal compaction effort required	50<CDI<450
Considerable additional compaction effort required	CDI>450

Conclusions from Workability Test Development

From results obtained for this task the following conclusions can be made:

1. The gyratory compaction curve defines workability (WEI) in the initial portion to eight gyrations and compactibility (CDI) from eight gyrations to the DVC or 100 gyrations.
2. Workability increases with increased b/a ratio. At a b/a greater than 19%, a significant decrease in required compaction energy was observed.
3. Once the cement was sufficiently wetted (around w/c 0.27), within the small range used for pervious concrete, additional water did not significantly affect either workability or compactibility.
4. The effect of mixing time on placeability shows a significant decrease in workability, causing a corresponding decrease in compactibility.
5. The defined ranges of the workability parameters can be used to assist designing pervious concrete mixtures for specific compaction methods and to allow quantification of placeability for overlay mixture development.

CHAPTER 5. DEVELOPMENT OF PERVIOUS CONCRETE MIXTURES FOR MECHANIZED PLACEMENT

Until now in the United States, PCPC has been generally used in parking areas, residential roads, alleys, and driveways for stormwater management. In Europe, Japan, and Australia, PCPC has also been successfully employed in limited highway applications. Portland cement pervious concrete designed for the current overlay has the potential to provide quieter and safer pavements by reducing traffic noise and water splash and spray and increasing skid resistance (Bax et al. 2007, Beeldens 2001, Olek et al. 2003, Vorobieff and Donald 2008).

One concern for the expanded use of PCPC as a structural material is relative low strength caused by high porosity required for high permeability. To minimize this deficiency and maximize environmental benefits, using PCPC as a pavement overlay material is a rational approach. Pavement overlaid with pervious concrete will not only function well structurally for carrying designed traffic loads, but also perform well environmentally for noise reduction and skid resistance.

To ensure good performance during both the construction and service periods, a PCPC mixture for a pavement overlay must possess the following properties:

- High workability for ease of placement
- Uniform porosity or void structure throughout the pavement for noise reduction
- Adequate bond with underlying pavement and proper strength for traffic load
- Sufficient resistance to wearing, aggregate polishing, and freezing-thawing damage

While a PCPC overlaid on existing concrete had previously never been attempted, a mixture with good durability and bond to the subsequent surface should have similar performance to traditional concrete overlays.

This chapter presents a systematic study conducted to investigate effects of a wide variety of concrete materials and mixture proportions on PCPC performance. The evaluated mixture performance parameters included concrete workability, compaction density, strength, freeze-thaw durability, and overlay bond strength.

The results indicate that PCPC mixtures can be designed to be highly workable, sufficiently strong, permeable, and with excellent freeze-thaw durability. Such PCPC mixtures are suitable for pavement overlays. The pavement with a PCPC overlay will not only function well structurally for carrying designed traffic loads, but also perform well environmentally for noise reduction and skid resistance.

Concrete Materials and Mixture Proportions

Table 13 summarizes the material and mixture proportion parameters studied for the present project. Many of the variables and starting mixture proportions were based on results presented in the previous chapters and other related previous work (Kevern 2006; Kevern et al. 2008b; Kevern et al. 2010; Schaefer et al. 2006; Wang et al. 2006b).

Table 13. Mixture matrix summary

Evaluated Parameters	Tested Values and Components
Aggregate shape	Round, angular
Sand content (fine aggregate/coarse aggregate)	0, 7.5, 10, 12.5, 15%
Cementitious content (b/a)	10, 15, 20, 22.5, 24, 25
Supplementary cementitious materials	Fly ash, slag
Water-to-cementitious	0.27, 0.29, 0.31, 0.33
Fiber type/length	Poly short, poly long, cellulose short
Fiber dosage (kg/m ³)	0, 0.9, 1.8, 3.0
Admixtures	HRWR, AEA, HS, latex, VMA

Previous study has suggested that concrete made with angular aggregate generally requires more paste to produce a given workability than pervious concrete made with like-sized rounded aggregate (Kevern et al. 2009a; Kevern et al. 2010; Schaefer et al. 2006). For a given aggregate type, PCPC made with angular aggregate commonly has higher tensile strength than concrete produced with rounded aggregate when comparing two PCPCs having similar densities and void contents. Angular/crushed aggregate also has better paste-to-aggregate bonding and generally provides pervious concrete with better freeze-thaw durability than most rounded aggregates (Schaefer et al. 2006). Therefore, locally available crushed granite was selected as the coarse aggregate (CA) for PCPC. The CA had 18% (by weight) passing the 4.75 mm (No. 4) sieve, specific gravity of 2.65, absorption of 0.59%, and compacted voids of 45%. In addition to the sand-sized particles present in the CA, 10% river sand was used as fine aggregate (FA). As a result, the combined aggregate gradation in the studied PCPC contained approximately 30% FA. Since both the CA and FA had similar specific gravities, the FA/CA ratios expressed by mass and volume in the PCPC proportions were similar.

Total cementitious content was varied to achieve the proper paste thickness surrounding the aggregate for workability and for strength and durability (Kevern et al. 2008c). The initial paste content of 24% by weight of aggregate was selected to achieve proper paste thickness for the desired workability on the relatively finely graded angular CA (Kevern et al. 2009a). With the selected aggregate gradation, two additional cementitious contents were evaluated. Supplementary cementitious materials (SCMs) were investigated in both binary and ternary combinations up to 50% replacement for portland cement. Fifty percent SCM replacement for cement has become common in some state Departments of Transportation (DOTs) and often results in improved properties compared to straight cement mixtures (Tikalsky et al. 2007).

The water-to-cement ratio was varied across typical values for PCPC. Various fiber lengths and types were investigated at three addition rates up to 3.0 kg/m^3 (5.0 pcy) of concrete. Two lengths of fibrillated polypropylene fibers were investigated, a longer fiber (PL) with a length of 50 mm (2 in.) and a shorter fiber (PS) with a gradation of lengths ranging from 12 mm (0.5 in.) to 25 mm (1 in.). Cellulose microfibers (CS) were also investigated with a maximum length of 2 mm (0.1 in.). Both the polypropylene fibers had a denier of 360 and 2.5–3.0 for the cellulose fiber. Various combinations of fibers were also studied. The usage of fibers in pervious concrete for improved freeze-thaw durability and permeability was first presented by Kevern (Kevern et al. 2008b).

Additionally, in this study, fibers were used as workability modifiers. Admixtures were investigated individually and in combinations at typical and increased dosage rates. The standard baseline mixture contained a polycarboxylate HRWR, vinsol resin AEA, as typical for laboratory pervious concrete (Kevern 2006; Kevern et al. 2008b; Schaefer et al. 2006). Dosages were 0.25% and 0.13%, respectively, from previous testing (Schaefer et al. 2006). Additional admixtures included a hydration stabilizing admixture (HS), a polysaccharide viscosity modifier (VMA), and a 2% solids triethanolamine latex polymer additive (LX) successfully used in pervious concrete by the Australian transportation ministry (Vorobieff and Donald 2008). Since traditional concrete overlays have been successful with and without bonding agents, two versions of the selected mixture proportions were studied, one with a latex polymer additive and one without.

With consideration of all the above-mentioned variables, a variety of PCPC proportions were selected as shown in Table 14 for the basic mixtures and Table 15 for the more advanced mixtures. All the mixtures were designed to yield 17.5% voids. Mixture iterations were based on workability, seven-day compressive strength, and seven-day splitting tensile strength using a partial factorial offspring progression where the next set of variables are applied to the selected mixture from the previous set of tests. The selected mixture represents the best performance (workability and strength) from the progeny and then becomes the baseline mixture for the next set of variables. The breeding process continues through the testing matrix, and the final mixture represents a genetic offspring of the previous test variables as selected by progressive traits. After the final mixture proportions were selected, compaction density curves were developed and calibrated to the placing equipment following the procedure developed by Kevern (Kevern et al. 2009b).

Table 14. PCPC mixture proportions for variables related to basic concrete materials

Mixture Design Variables	Mixture ID	Cement	Slag	Fly Ash	Water	CA	FA
		kg/m ³ (lb/yd ^{3a})	kg/m ³ (lb/yd ³)	kg/m ³ (lb/yd ³)	kg/m ³ (lb/yd ³)	kg/m ³ (lb/yd ³)	kg/m ³ (lb/yd ³)
Sand	B24	380 (640)	0 (0)	0 (0)	110 (190)	1571 (2650)	0 (0)
	B24-S7.5	380 (640)	0 (0)	0 (0)	110 (190)	1480 (2490)	110 (190)
	<u>B24-S10</u>	380 (640)	0 (0)	0 (0)	110 (190)	1440 (2430)	140 (240)
	B24-S12.5	380 (640)	0 (0)	0 (0)	110 (190)	1410 (2380)	180 (300)
	B24-S15	380 (640)	0 (0)	0 (0)	110 (190)	1380 (2320)	210 (350)
Binder amount	B21-S10	350 (580)	0 (0)	0 (0)	100 (170)	1500 (2520)	150 (250)
	B22.5-S10	360 (610)	0 (0)	0 (0)	100 (170)	1470 (2480)	150 (250)
	<u>B24-S10</u>	380 (640)	0 (0)	0 (0)	110 (190)	1440 (2430)	140 (240)
	B21-S10 (0.33)	340 (570)	0 (0)	0 (0)	110 (190)	1470 (2480)	150 (250)
	B22.5-S10 (0.33)	360 (600)	0 (0)	0 (0)	120 (200)	1440 (2430)	140 (240)
w/c	B24-S10 (0.33)	370 (630)	0 (0)	0 (0)	110 (180)	1420 (2390)	140 (240)
	B24-S10 (0.27)	380 (650)	0 (0)	0 (0)	100 (170)	1460 (2430)	150 (250)
	<u>B24-S10 (0.29)</u>	380 (640)	0 (0)	0 (0)	110 (190)	1440 (2430)	140 (240)
	B24-S10 (0.33)	370 (630)	0 (0)	0 (0)	110 (180)	1420 (2390)	140 (240)

Table 15. PCPC mixture proportions for variables related to fibers and admixtures

Mixture Design Variables	Mixture ID	PL	PS	CS	VMA	HS	LX
		kg/m ³ (lb/yd ³)	kg/m ³ (lb/yd ³)	kg/m ³ (lb/yd ³)	mL/kg (oz/cwt)	mL/kg (oz/cwt)	mL/kg (oz/cwt)
Fiber type	B24-S10-PL1.5	0.9 (1.5)	0 (0)	0 (0)	0 (0)	0 (0)	0 (0)
	<u>B24-S10-PS1.5</u>	0 (0)	0.9 (1.5)	0 (0)	0 (0)	0 (0)	0 (0)
	B24-PS1.5	0 (0)	0.9 (1.5)	0 (0)	0 (0)	0 (0)	0 (0)
	B24-S10-CS1.5	0 (0)	0 (0)	0.9 (1.5)	0 (0)	0 (0)	0 (0)
Fiber dosage rate	<u>B24-S10-PS1.5</u>	0 (0)	0.9 (1.5)	0 (0)	0 (0)	0 (0)	0 (0)
	B24-S10-PS3	0 (0)	1.8 (3.0)	0 (0)	0 (0)	0 (0)	0 (0)
	B24-S10-PS5	0 (0)	2.7 (5.0)	0 (0)	0 (0)	0 (0)	0 (0)
	B24-S10-CS1.5	0 (0)	0 (0)	0.9 (1.5)	0 (0)	0 (0)	0 (0)
	B24-S10-PS1.5-CS1.5	0 (0)	0.9 (1.5)	0.9 (1.5)	0 (0)	0 (0)	0 (0)
Binder composition	B24(100,0,0)-S10-CS1.5	0 (0)	0 (0)	0.9 (1.5)	0 (0)	0 (0)	0 (0)
	<u>B24(50,35,15)-S10-CS1.5</u>	0 (0)	0 (0)	0.9 (1.5)	0 (0)	0 (0)	0 (0)
	B24(50,25,25)-S10-CS1.5	0 (0)	0 (0)	0.9 (1.5)	0 (0)	0 (0)	0 (0)
	B24(50,15,35)-S10-CS1.5	0 (0)	0 (0)	0.9 (1.5)	0 (0)	0 (0)	0 (0)
	B24(50,50,0)-S10-CS1.5	0 (0)	0 (0)	0.9 (1.5)	0 (0)	0 (0)	0 (0)
	B24(50,0,50)-S10-CS1.5	0 (0)	0 (0)	0.9 (1.5)	0 (0)	0 (0)	0 (0)
Admixtures	B24(50,35,15)-S10-CS1.5-VMA5	0 (0)	0 (0)	0.9 (1.5)	3 (5)	0 (0)	0 (0)
	B24(50,35,15)-S10-CS1.5-HS6	0 (0)	0 (0)	0.9 (1.5)	0 (0)	4 (6)	0 (0)
	B24(50,35,15)-S10-CS1.5-HS12	0 (0)	0 (0)	0.9 (1.5)	0 (0)	8 (12)	0 (0)
	B24(50,35,15)-S10-CS1.5-VMA5-HS12	0 (0)	0 (0)	0.9 (1.5)	3 (5)	0 (0)	8 (12)
	B24(50,35,15)-S10-CS1.5-LX12	0 (0)	0 (0)	0.9 (1.5)	0 (0)	8 (12)	0 (0)
Selected Mixtures	B24(50,35,15)-S10-CS1.5-VMA5-HS12	0 (0)	0 (0)	0.9 (1.5)	3 (5)	8 (12)	8 (12)
	B24(50,35,15)-S10-CS1.5-LX12-HS12	0 (0)	0 (0)	0.9 (1.5)	0 (0)	8 (12)	8 (12)

Testing Procedures

The following are testing procedures unique for development of the pervious concrete overlay. Workability and compaction density procedures were developed specifically for this project and have been applied to many subsequent designs (Kevern et al. 2009a, Kevern and Montgomery 2010).

Strength and Durability

Compressive strength was tested on 100 mm x 200 mm (4 in. x 8 in.) sulfur capped cylinders according to ASTM C39 and C617 (ASTM C39 2003; ASTM C617 2003). Splitting tensile strength was tested on 100 mm diameter specimens according to ASTM C496 (2003). Freeze-thaw durability was tested according to ASTM C666, procedure A, fully saturated rapid technique using a 60% relative dynamic modulus of elasticity criterion according to ASTM C215 (C666 2003; C215 2003). Surface abrasion was measured using the ASTM C944 rotary cutter method on samples before and after freeze-thaw testing (ASTM C944 2005).

Sample Placement and Compaction Density

The results shown in Table 15 and Table 16 and Figures 22, 23, 24, 25, 26, and 27 are from samples placed by a single experienced operator. Concrete cylinders were placed in three lifts, lightly rodding each lift with 25 strokes. All data represents an average of three test specimens with a coefficient of variation less than 15%. The freeze-thaw durability specimens were placed at exactly the DVC by placing a predetermined mass into the known sample mold volume. Compaction was achieved by lightly rodding the concrete in two lifts.

The creation of compaction density curves is necessary to evaluate pervious concrete material properties over a range of void contents. Since a particular mixture can result in a wide range of material properties related to density, compaction density curves are needed to encompass potential installed values. Cylinder samples and modulus of rupture beams of selected mixtures were placed at three different densities to encompass the desired field density. The cylinders were then tested for unit weight, voids, permeability, and strength development with time. Voids were determined using water displacement and the procedure outlined by Montes et al. (2005). The resulting compaction density relationships allow specification of DVC with individual compaction equipment and verification of delivered fresh concrete properties. Additional information on creation of compaction density relationships for pervious concrete is provided by Kevern (Kevern and Montgomery 2010; Kevern et al. 2009b).

Results and Discussion

Table 15 shows the voids, unit weight, and workability parameters (CDI and WEI) of fresh PCPC as well as seven-day compressive strength of the hardened PCPC studied, for all mixtures in the progression toward the selected mixtures shown in Table 16. The mixture iterations were based on seven-day strengths due to the opening criteria of pervious concrete being cured for seven days before removal of the plastic. The effects of concrete material and mixture proportion variables on the PCPC properties are discussed in the sections below.

Table 15. PCPC test results

Mixture Design Variables	Mixture ID	Voids (%)	Unit Wt., kg/m ³ (pcf)	7d Comp. St., MPa (psi)	CDI	WEI
Sand	B24	32.5	1770 (111)	12.3 (1780)	592	650
	B24-S7.5	31.1	1850 (116)	19.2 (2790)	613	625
	<u>B24-S10</u>	28.7	1850 (116)	17.9 (2600)	630	187
	B24-S12.5	22.7	1950 (122)	11.4 (1660)	636	112
	B24-S15	31.4	1820 (114)	9.8 (1420)	625	99
Binder amount	B21-S10	29.3	1860 (116)	14.8 (2140)	611	663
	B22.5-S10	28.1	1890 (118)	15.5 (2250)	624	266
	<u>B24-S10</u>	28.7	1850 (116)	17.9 (2600)	630	187
	B21-S10 (0.33)	28.4	1830 (114)	11.2 (1630)	609	662
	B22.5-S10 (0.33)	20.3	1910 (119)	13.3 (1920)	621	517
	B24-S10 (0.33)	13.0	1960 (122)	13.5 (1970)	628	193
w/c	B24-S10 (0.27)	32.6	1820 (114)	12.1 (1750)	618	244
	<u>B24-S10 (0.29)</u>	28.7	1850 (116)	17.9 (2600)	630	187
	B24-S10 (0.33)	13.0	1960 (122)	13.5 (1970)	628	193
Fiber type	B24-S10-PL1.5	24.1	1920 (120)	14.4 (2100)	619	389
	<u>B24-S10-PS1.5</u>	18.4	1970 (123)	19.5 (2830)	621	380
	B24-PS1.5	27.9	1860 (116)	16.1 (2340)	650	48
	B24-S10-CS1.5	26.2	1940 (121)	20.6 (2990)	626	251
Fiber dosage rate	<u>B24-S10-PS1.5</u>	18.4	1970 (123)	19.5 (2830)	621	380
	B24-S10-PS3	24.9	1940 (121)	19.2 (2790)	617	431
	B24-S10-PS5	26.8	1900 (118)	14.6 (2120)	607	666
	B24-S10-CS1.5	26.2	1940 (121)	20.6 (2990)	626	251
	B24-S10-PS1.5-CS1.5	28.8	1880 (117)	16.2 (2346)	621	310
Binder composition	B24(100,0,0)-S10-CS1.5	26.2	1940 (121)	20.6 (2990)	626	251
	<u>B24(50,35,15)-S10-CS1.5</u>	22.7	1980 (123)	17.6 (2560)	638	113
	B24(50,25,25)-S10-CS1.5	19.5	1990 (124)	16.8 (2440)	644	103
	B24(50,15,35)-S10-CS1.5	21.5	1970 (123)	14.9 (2160)	635	115
	B24(50,50,0)-S10-CS1.5	19.8	2010 (125)	23.7 (3437)	636	84
	B24(50,0,50)-S10-CS1.5	23.8	1910 (119)	14.3 (2070)	641	86
Admixtures	B24(50,35,15)-S10-CS1.5-VMA5	20.5	1930 (120)	12.5 (1810)	637	110
	B24(50,35,15)-S10-CS1.5-HS6	21.3	1960 (123)	17.6 (2560)	635	139
	B24(50,35,15)-S10-CS1.5-HS12	24.7	1950 (122)	19.8 (2870)	642	82
	B24(50,35,15)-S10-CS1.5-VMA5-HS12	20.9	1980 (124)	20.3 (2940)	689	0
	B24(50,35,15)-S10-CS1.5-LX12	25.1	1910 (119)	15.1 (2190)	617	634

Table 16. Selected mixtures and their test results

Mixture ID	B24(50,35,15)-S10-CS1.5-PS1.5-VMA5-HS12	B24(50,35,15)-S10-CS1.5-PS1.5-LX12-HS12
Voids (%)	17.2	23.0
Unit Wt., kg/m ³ (pcf)	1950 (122)	1950 (122)
7d Comp. St., MPa (psi)	17.2 (2500)	15.9 (2300)
21d Comp. St., MPa (psi)	19.7 (2860)	22.8 (3310)
28d Comp. St., MPa (psi)	21.2 (3070)	23.2 (3360)
28d Spl. T., MPa (psi)	2.70 (395)	2.80 (410)
Perm., cm/s (in/hr)	0.12 (170)	0.21 (300)
WEI	689	692
CDI	0	0

Workability and Strength Performance

Figure 22 illustrates the effect of binder content on the concrete workability, strength, and porosity. The selected baseline mixture contained 10% FA to CA, cement, and a w/c ratio of 0.29. The range of b/a combinations selected represented common cement contents for aggregate with similar surface area values that had produced successful placements in the past. It has been observed that b/a values less than 21% (by mass of straight cement using aggregate with specific gravity values around 2.62) had high porosity but low strength. It was also observed that a b/a above 24% had good strength but low permeability (Kevern 2006; Schaefer et al. 2006). At an increasing b/a the initial workability (WEI) slightly increased while the resistance to compaction significantly decreased (CDI). Porosity was not impacted by the additional binder, although more binder did improve strength. A binder-to-aggregate ratio of 24% was selected due to the highest strength and workability and lowest resistance to additional compaction.

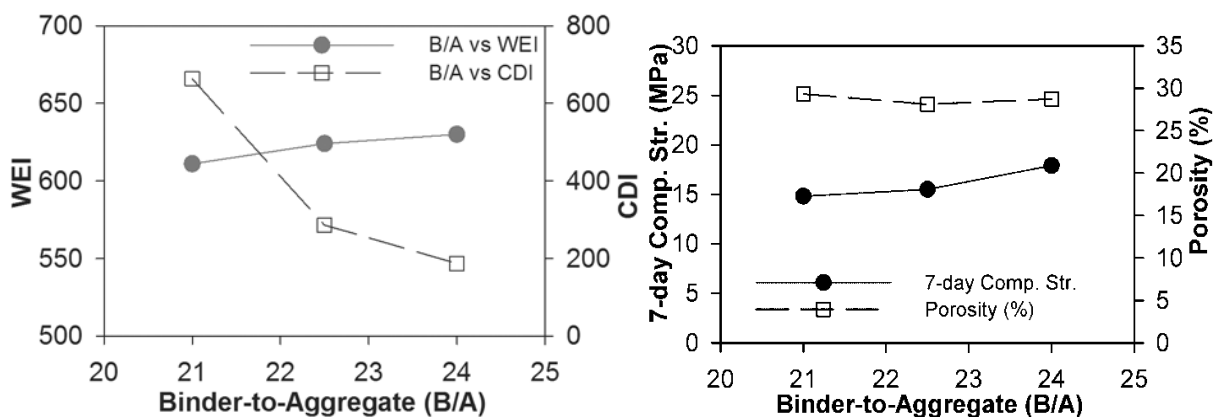

Figure 22. Binder-to-aggregate ratio versus workability, strength, and porosity

The effect of w/c on workability and material properties is shown in Figure 23 for mixtures containing a b/a of 24%, 10% additional fine aggregate, and cement. Previous research has shown that at a w/c less than 0.27 typical pervious concrete (standard admixture types and

dosages), the paste is not sufficiently wetted and has poor strength and durability. Again, for typical pervious concrete mixtures, a w/c above 0.33 causes the excess paste to drain from the aggregate (Kevern et al. 2008c, 2008d). Consequently, a range of w/c from 0.27 to 0.33 was studied for overlay applications. Additional water slightly improved workability and caused a significant reduction in porosity at a w/c of 0.33. However, strength was a highest of 17.9 MPa (2,600 psi) at the selected w/c of 0.29.

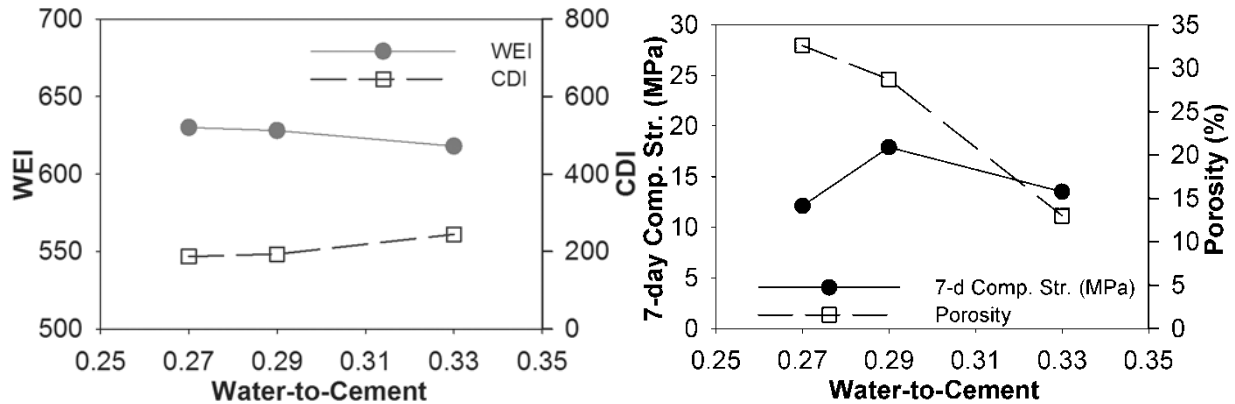

Figure 23. Effect of water-to-cement ratio on workability, strength, and porosity

The effect of gradation/sand content is shown in Figure 24 for mixtures containing a b/a of 24% and a w/c of 0.29. Since the original CA gradation had 18% passing the 4.75 mm (No. 4) sieve, a maximum of 15% additional FA was investigated. The FA had a similar specific gravity to the CA, so the FA/CA is either by mass or volume. Workability (WEI) increased with increased sand content. At an FA/CA of less than 7.5%, there was no difference in resistance to compaction. However, at an FA/CA of greater than 7.5%, the FA increased the paste/mortar thickness around the aggregate and reduced resistance to further compaction. Porosity decreased with increased workability up to an FA/CA of 12.5%. At the 15% level, the amount of sand stiffened the mortar and held the CA particles apart. While porosity decreased to the 12.5% level, the seven-day compressive strength peaked at the 7.5% level at 19.2 MPa (2,793 psi). Because of the decrease in resistance to compaction between the 7.5% and 10% rate and only a slight decrease in compressive strength, an FA/CA of 10% was selected for this application.

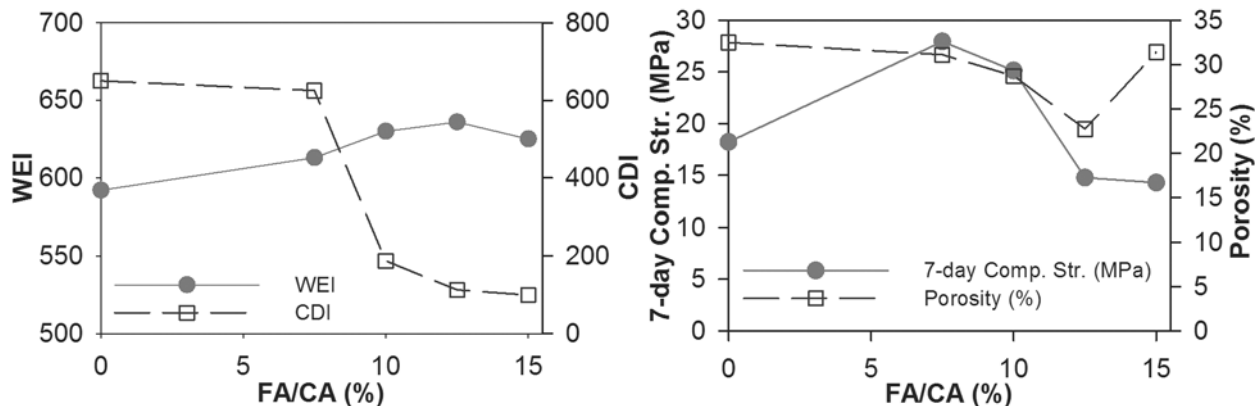

Figure 24. Effect of fine aggregate content on workability, strength, and porosity

The effects of different types of fibers on the workability of a mixture containing a b/a of 24%, a w/c of 0.29, and an FA/CA of 10% are shown for both the PS and CS. General trends were the same for both fiber types. Additional fibers slightly decreased workability and increased the resistance to additional compaction. Mixtures containing PSs had a linear increase in resistance to additional compaction, while no significant increase was observed for the CSs until the 3.0 kg/m³ (5.0 pcy) rate. All mixtures had similar increases in tensile and compressive strengths at the 0.9 kg/m³ (1.5 pcy) and 1.8 kg/m³ (3.0 pcy) rates and a decrease in compressive strength at the 3.0 kg/m³ (5.0 pcy) rate. One interesting observation was noted: mixtures containing the PSs were not extrudable if highly workable and self-consolidating (CDI <50), but all mixtures containing the CSs were extrudable independent of workability. The selected design contained both types of fibers each at the 0.9 kg/m³ (1.5 pcy) rate.

Once the primary components of aggregate type, binder content, w/c, and sand content were selected, additional mixture variables were investigated. A range of binary and ternary cementitious material combinations were investigated up to 50% replacement for portland cement. The SCMs included class C fly ash and grade 120 ground granulated blast furnace slag. Mixture iterations were based on seven-day strengths due to the opening criteria of pervious concrete being cured for seven days before removal of the plastic. Because of the slower strength development rates, higher SCM replacement rates were not investigated. 28 shows the workability responses of the SCM mixtures where the numbers in brackets represent the percentage of portland cement, slag, and fly ash, respectively. All SCM combinations were more workable and required less additional compaction than the 100% portland cement mixture. Also, all SCM combinations containing at least 25% slag had higher seven-day tensile strengths and similar compressive strength values as the 100% portland cement mixture (Figure 25).

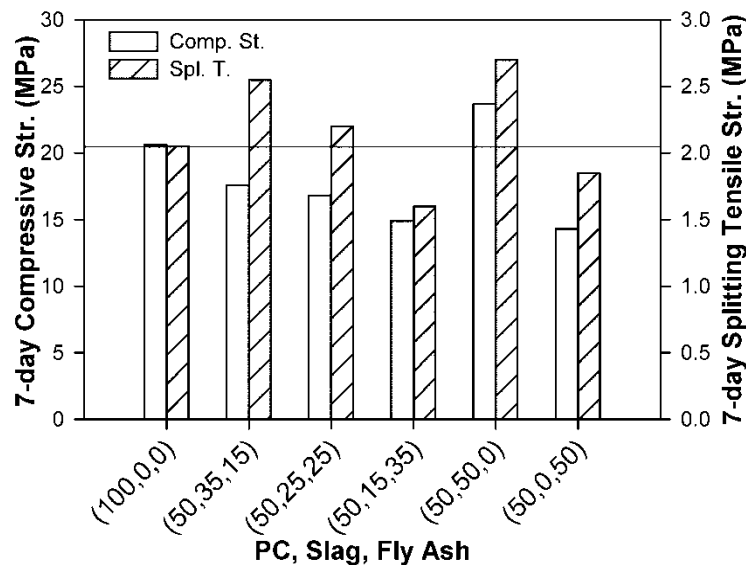

Figure 25. Effects of SCMs on strength (B24["x"]-S10-CS1.5-w/c0.29)

The highest seven-day compressive and tensile strengths were achieved by the mixture containing 50% slag of 23.7 MPa (3,440 psi) and 2.7 MPa (390 psi), respectively. The mixture containing 35% slag and 15% fly ash had a lower seven-day compressive strength of 17.6 MPa

(2,554 psi) but a similar tensile strength of 2.6 MPa (370 psi). Due to the potential for greater long-term strength gain from the fly ash, a ternary blend of 35% slag and 15% fly ash was selected.

The final mixture options for investigation were the admixture combinations (Figure 26). Other admixtures tested were in addition to the standard admixtures for field-placed pervious concrete of polycarboxylate HRWR, air entrainer, and HS. The admixtures and combinations included single and double dosages of the HS, with and without a VMA, and an LX for concrete block mixtures. The mixture containing the VMA and double the recommended dosage of HS had the highest seven-day tensile strength of 2.7 MPa (390 psi). Both latex combinations produced similar seven-day tensile strengths around 2.1 MPa (300 psi). The latex mixtures were cured in the humidity chamber for seven days, removed from the humidity chamber and allowed to dry for seven days, and then placed back into the humidity chamber for the remaining curing time. The drying cycle allowed formation of the secondary latex film system. However, seven-day values for the latex mixtures did not allow drying time and had lower strengths than the mixtures without latex. At 28 days, after drying, the latex samples had higher compressive and tensile strengths than the mixtures without latex. One set of mixture proportions was selected and produced with two admixture schemes, with and without the latex additive.

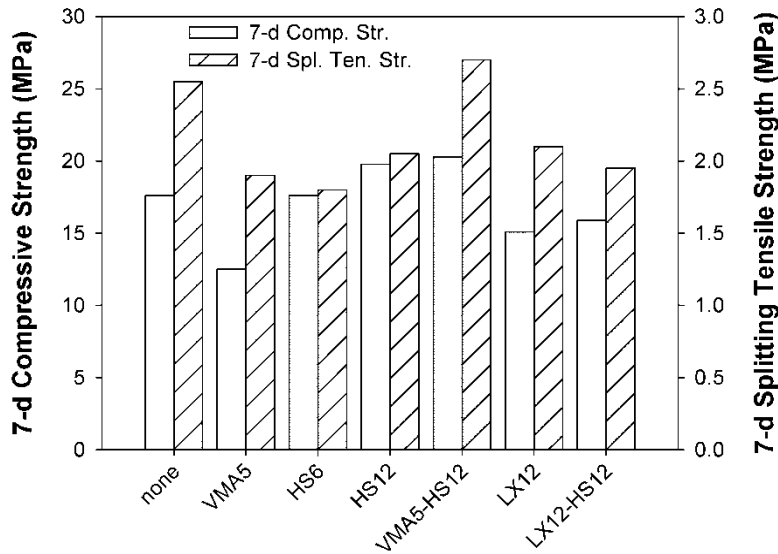

Figure 26. Effect of admixtures on strength (B24[50,35,15]-S10-CS1.5-w/c0.29)

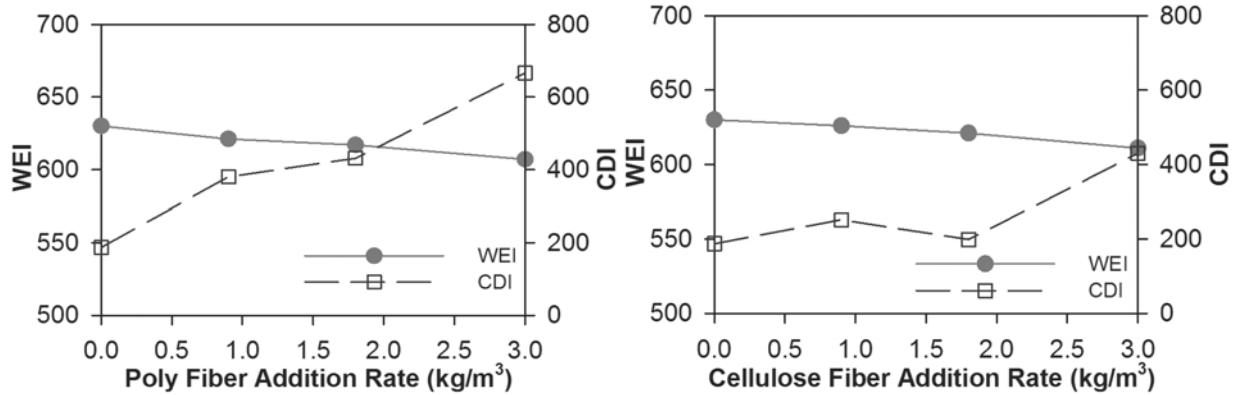

Figure 27. Effect of fiber type and addition rate on workability

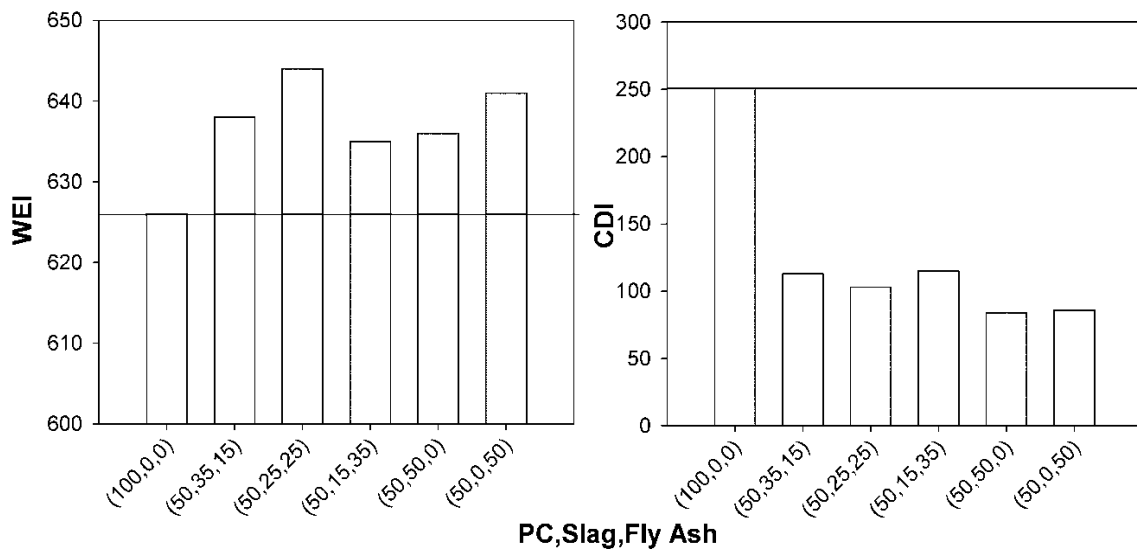

Figure 28. Effects of SCMs on workability (B24["x"]-S10-CS1.5-w/c0.29)

The Selected PCPC Mixture and Properties

Based on the test results and analysis, aggregate and mixture proportions for the PCPC overlay project were determined. Crushed granite CA containing 18% passing the 4.75 mm (No. 4) sieve was selected. The selected mixture contained a b/a of 24%, a w/c of 0.29, an additional FA-to-CA of 10%, 0.9 kg/m^3 (1.5 pcy) of both short graded polypropylene and cellulose micro fibers, and had 35% slag and 15% fly ash replacing portland cement. The nonlatex additive mixture had HRWR, AEA, HS, and VMA, while the latex mixture contained a latex concrete block additive, HRWR, AEA, and HS. Complete test results for the mixtures are shown in Table 16.

The compaction density relationships for the selected mixture are shown in Figure 29. As expected, unit weight and strength are linear with respect to voids as was tensile strength. Permeability exponentially increased with voids from 0.08 cm/s (288 in./hr) at the 17% void sample to over 2 cm/s (7,500 in./hr) at the 40% void samples. Figure 30 shows an initial trial of the concrete overlay in the laboratory. The sample was placed using a nonvibrating slip-form

grout box mini-paver. The test pavement was 400 mm (18 in.) wide and 100 mm (4 in.) thick, placed on a clean concrete surface. More information on the mini-paver setup can be found in Wang et al. (2008). The sample was self-consolidating, porosity was uniform across the section profile, and it had good edge-holding ability. After selecting the mixture constituents, testing workability, determining the compaction density relationships, and investigating porosity from the slip-forming process, the final mixture had a design void content of 22.5%.

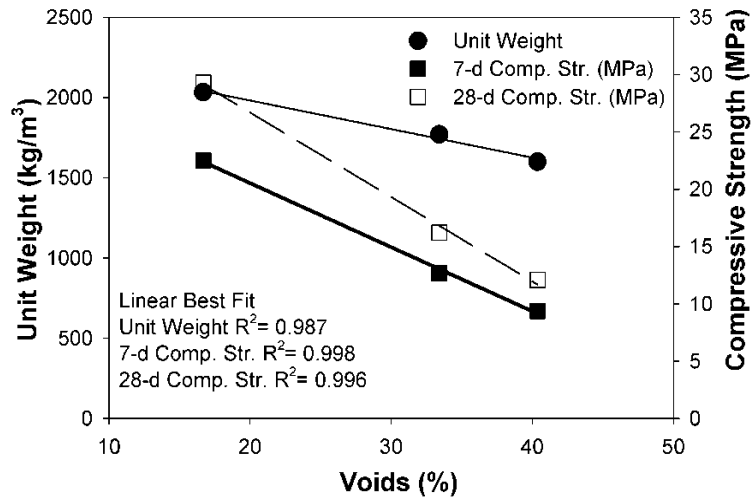

Figure 29. Compaction density relationships



Figure 30. Laboratory testing of the selected mixture

Freeze-Thaw Durability and Surface Durability

The freeze-thaw durability of both mixtures is shown in Figure 31, placed at the design void content of 22.5%. Each point represents an average of three test samples with a coefficient of deviation less than 10%. The mixtures were demolded after 24 hrs and placed in a 100% humidity fog room until testing began at 56 days, except for the previously mentioned latex

curing procedure. The latex polymer mixture had a durability factor of 100 and the nonlatex mixture a 95. Both mixtures had excellent freeze-thaw performance. Between 150 and 175 cycles, the samples were paused by placing the frozen samples into a laboratory freezer for two weeks to accommodate testing schedules. Pausing in a frozen state is approved within the ASTM C666 standard; however, a slight elastic modulus response was observed (C666 2003).

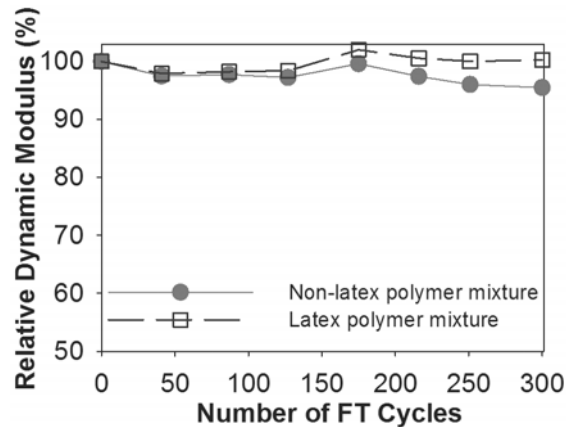

Figure 31. Freeze-thaw durability of the selected mixtures

Surface abrasion resistance was measured on freeze-thaw specimens before and after testing. The latex polymer mixture had slightly higher abrasion than the nonlatex mixture. Surface abrasion on pervious concrete is highly dependent on the CA type, and testing results are limited. However, abrasion results were 5% to 7% lower than the best performing pervious concrete mixture reported in the literature containing river gravel and no SCMs (Kevern et al. 2009c).

Mixture Proportioning Conclusions

The mixture development results detailed in this chapter produced pervious concrete suitable for the required overlay project. The results indicate that PCPC mixtures can be designed to be highly workable, sufficiently strong, permeable, and with excellent freeze-thaw durability, thus being suitable for pavement overlays. Detailed conclusions from this task are:

1. The modified gyratory test is a valuable method for evaluating the materials and mixture proportions used for highly workable pervious concrete.
2. Increased mortar content improves both workability and strength of pervious concrete.
3. Addition of cellulose fibers had limited impact on the initial workability of pervious concrete but significantly improved the edge-holding ability of the mixture, thus suitable for slip-form construction.
4. Use of 35% slag and 15% class C fly ash provided PCPC with good early-age and long-term performance.

5. Certain admixtures (water reducing, hydration stabilizing, and air entraining) are required to achieve the workability needed to obtain proper density and durability.
6. The selected PCPC mixture for the pavement overlay project demonstrated excellent freeze-thaw durability (with a durability factor above 95).

CHAPTER 6. EFFECT OF CURING ON MECHANICAL PROPERTIES AND SURFACE DURABILITY

Introduction

The freeze-thaw durability of PCPC has been studied in the laboratory and the findings show that this aspect may not be as much of a concern as initially believed (Delatte et al. 2007; Kevern 2006). When pervious concrete is applied to pavements in areas that undergo freeze-thaw, durability also refers to the surface abrasion resistance against snow-clearing operations. If pervious concrete is to progress from parking lot applications to overlay applications, the pavement must be resistant to all aspects of cold weather maintenance.

Concrete curing is required to maintain sufficient moisture to allow cement hydration and concrete microstructure development (Wang et al. 2006a). Also, curing has been shown to impact concrete durability as well as concrete strength (ACI 2000). Many techniques exist to control moisture loss in traditional concrete, although most are not appropriate for pervious concrete. Because of the high porosity of pervious concrete, rapid loss of moisture from the fresh concrete due to evaporation can occur. Since the w/c of the concrete is generally low, loss of moisture can result in rapid desiccation, low strength, and excessive surface raveling. Thus, curing is especially important for pervious concrete, because unlike traditional concrete, the bottom of the slab is exposed to air as much as the surface. On the other hand, protecting the surface may allow proper curing throughout. For PCPC, water misting or fogging washes the cement paste from the coated aggregate particles. Because of potential surface damage of the fresh concrete, wet burlap cannot be applied until final set has been reached, which results in excess surface desiccation. Liquid membrane-forming compounds prevent surface moisture loss but do nothing to prevent evaporation from within pervious concrete. Curing compounds are designed to prevent moisture loss from the surface of freshly placed concrete, which presents an obstacle for proper pervious concrete curing.

The current method of curing PCPC involves covering the fresh concrete with plastic sheets and allowing the pavement to cure for seven days before removal of the plastic. In most cases, the plastic sheets must be rolled onto a pipe for rapid application after placement and aggregate or sand bags must be used to seal the edges and prevent wind from ballooning under the plastic and drying the surface. Covering with plastic is the preferred method to cure pervious concrete but can be problematic, and no studies have been performed to determine if that is sufficient or even required. This task evaluated the effect of nine different curing methods or curing materials on pervious concrete properties, including flexural strength and surface abrasion resistance.

Testing Procedures

Flexural strength was determined using modulus of rupture of the beams tested at 28 days according to ASTM C78 (2002). Once the samples were tested for modulus of rupture, the fractured pieces were tested for surface abrasion. Surface abrasion was determined according to ASTM C944 (2005), in which a constant load of 98 N (22 lbs) is applied through rotary cutter dressing wheels in contact with the sample surface for two minutes. The diameter of the circular

abraded area is 80 mm (3.25 in.). The beams were first cleaned with a stiff-bristled brush and vacuumed on all sides to remove any loose materials. After each abrasion test, the beams were again brushed clean and vacuumed to remove loose debris. The mass loss between trials was recorded, and a total of six abrasion tests were performed on each set of beams. Figure 32 shows the abrasion device with the shaft-mounted container for load calibration and abrasion head cutting device. The physical result of an abrasion test is shown in Figure 33 for a beam cured with the standard white-pigment curing compound. The left portion of the sample had not undergone testing, while the tested portion is the exposed aggregate circular section on the right. The Abrasion Index (AI) was taken as the ratio of the average abraded mass loss for a particular sample divided by the average for the control mixture with no curing method.

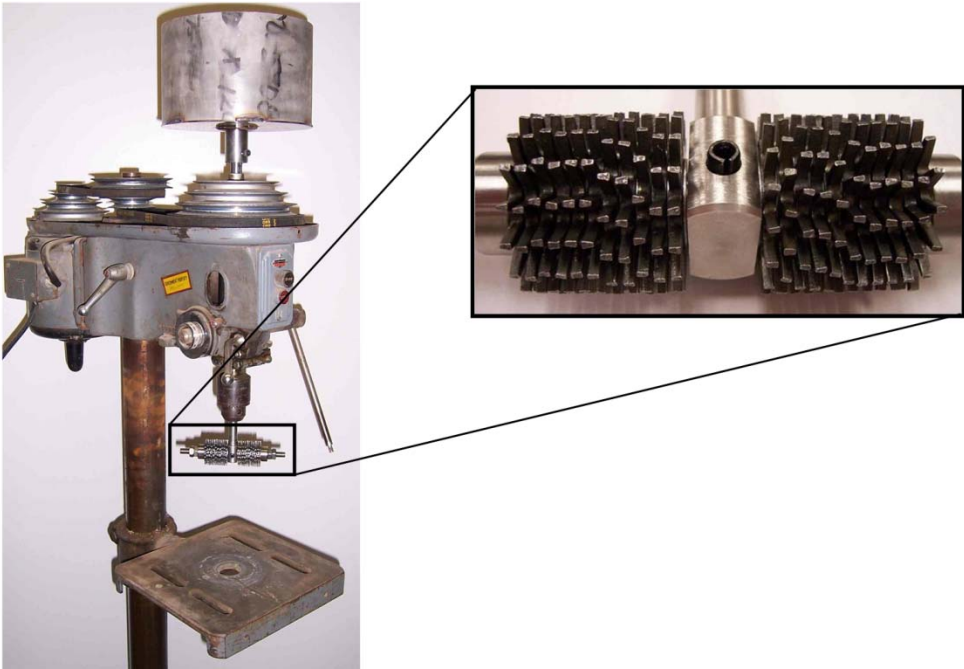

Figure 32. Abrasion apparatus and cutting head

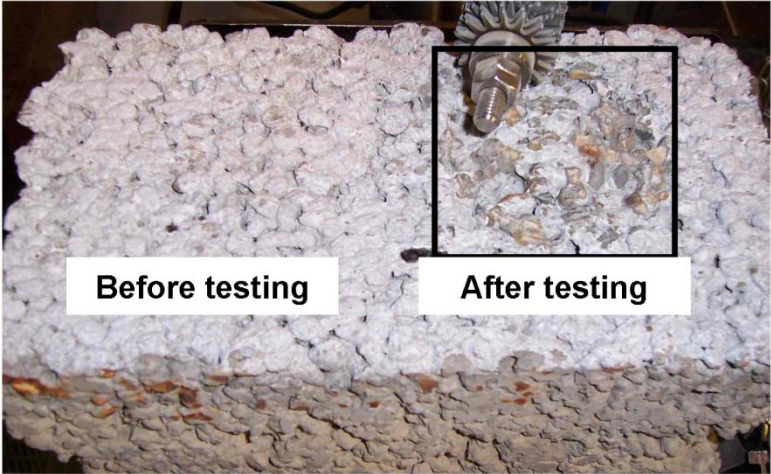

Figure 33. Surface before and after abrasion

After abrasion, three 75 mm (3 in.) core samples were extracted from each beam. The ends were then trimmed using a concrete slab saw to correct uneven surfaces and provide a uniform volume for porosity calculation. The porosity of the pervious concrete was determined by taking the difference in weight between a sample oven-dry and submerged under water using the proposed procedure developed by Montes et al. (2005).

After determining porosity, the concrete permeability was decided upon using a falling head permeability test apparatus. A flexible sealing gum was used around the top perimeter of a sample to prevent water leakage along the sides of the sample. The samples were then confined in a latex membrane and sealed in a rubber sleeve, which was confined by adjustable hose clamps. The average coefficient of permeability (k) was determined following Darcy's law and assuming laminar flow (Kevern 2006).

Abrasion of Reference Concrete

The strength and performance of pervious concrete is directly impacted by the in-situ density, which is a factor of the mixture workability and compaction effort applied to the fresh concrete. It is well understood that pervious concrete with high porosity and low unit weight has lower compressive strength and durability (surface particle raveling and freeze-thaw resistance) than denser concrete with the same mixture proportions. Some degree of compaction variability occurs during field placement, and the American Concrete Institute (ACI) 522 pervious concrete committee recommends the concrete placement be within $\pm 80 \text{ kg/m}^3$ (5 pcf) of the design unit weight (ACI 2010).

Before determining the effect of curing method on surface abrasion, samples with the same mixture proportions were placed at three different densities to determine variability of surface abrasion within the allowable density variation. Based on previous research (Kevern 2006; Kevern et al. 2005; Schaefer et al. 2006), a control mixture design was selected that contained river gravel aggregate, a small portion of additional sand, and 15% fly ash replacement for cement. The freeze-thaw durability of the concrete has been previously investigated, and similar mixtures were installed for the Iowa water quality study pervious parking lot (Jones 2006).

The mixture proportions for the initial study are shown in Table 17. The river (pea) gravel CA had 97% passing the 9.5 mm (3/8 in.) sieve and 81% retained on the 12.7 mm (No. 4) sieve (#4PG). Additionally, 5% fine aggregate by weight of coarse aggregate (S5) was included. The fine aggregate was river sand with a fineness modulus of 2.9. The cement was Type II, marketed as a Type I-II, and the amount of cementitious material was fixed at 21% by the weight of aggregate (B21). Class C fly ash replaced 15% of the Type II cement by weight (FA15). Therefore, the control mixture was designated as #4PG-B21-FA15-S5.

Table 17. Calibration mixture proportions

Design Unit Weight, kg/m ³ (pcf)	Design Void Content (DVC), %	CA kg/m ³ (pcf)	FA kg/m ³ (pcf)	PC kg/m ³ (pcf)	Fly Ash kg/m ³ (pcf)	w/c
1,940 (121)	22.5	1,340 (85)	70 (4)	270 (17)	40 (2)	0.27
1,870 (117)	25.0	1,400 (88)	70 (4)	280 (17)	40 (3)	0.27
1,810 (113)	27.5	1,450 (91)	70 (5)	280 (18)	40 (3)	0.27

The control mixture was placed at three density levels and cured under ideal laboratory conditions in a humidity chamber for 28 days (ASTM C192 2003) and allowed to air dry 24 hours before abrasion testing. The results for the calibration specimens are shown in Figure 34, where the error bars represent the standard deviation for three replicate samples. While there was a slight decrease in average material abraded with increased density, 2.88 g for the 1,810 kg/m³ (113 pcf) sample to 2.58 g for the 1,940 kg/m³ (121 pcf) sample, comparing the standard deviation between samples, there was no significant difference in abrasion within the range of allowable density.

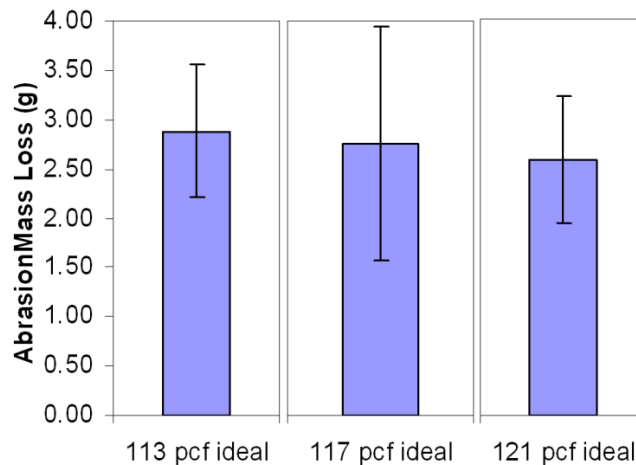
**Figure 34. Abrasion results for calibration specimens**

Field Trial Mixture Proportions

The mixture proportions for the field trials were based on the previously described control mixture and are shown in Table 18. Additional modified concrete mixtures included an integral crystalline water-proofing agent added per manufacturer’s specification at 2% by weight of cementitious materials (CWPA) in Mixture #3. Polypropylene fibers were included in Mixture #4 at the manufacturer’s recommended dosage of 0.9 kg/m³ (1.5 pcy) or 0.1% by volume (F1.5) (Propex Concrete Systems 2008). The fibrillated fibers had a specific gravity of 0.91 and contained a gradation of length between 19 mm (0.75 in.) and 38 mm (1.5 in.). One mixture also included 100% portland cement as the binder.

Table 18. Mixture proportions

Mixture #	CA kg/m ³ (pcf)	FA kg/m ³ (pcf)	PC kg/m ³ (pcf)	Fly Ash kg/m ³ (pcf)	CWPA kg/m ³ (pcf)	Fibers kg/m ³ (pcf)	w/c
1	1,530 (91)	80 (5)	300 (19)	40 (3)	-	-	0.27
2	1,530 (91)	80 (5)	340 (21)	-	-	-	0.27
3	1,530 (91)	80 (5)	300 (19)	40 (3)	10 (0.5)	-	0.27
4	1,530 (91)	80 (5)	300 (19)	40 (3)	-	0.9 (1.5)	0.27

Along with air curing, five curing regimes were tested on the control mixture (Table 19). The external curing regimes included covering with plastic sheets for seven days and 28 days. Curing compounds were sprayed on the concrete at the manufacture's recommended dosage rates and included a standard white-pigment curing compound applied at 4.9 m²/liter (1) (200 ft²/gallon [gal]), a soybean oil emulsion curing compound applied at 4.9 m²/l (200 ft²/gal), and a non-film forming evaporation retardant applied at 16.3 m²/l (800 ft²/gal).

In addition to the control mixture, one mixture containing 100% portland cement was cured with plastic sheets for seven days, one mixture containing fibrillated polypropylene fibers was cured with plastic sheets for seven days, and one mixture containing the internal crystalline water-proofing agent that was surface cured with the non-film forming evaporation retardant. The internal crystalline water-proofing agent was a dry powder integrally mixed with the cement to reduce the permeability of the cement paste (XYPEX 2000). It was thought the mechanism in reduction of permeability would help seal in moisture and provide a more complete cure. The non-film forming evaporation retardant was designed to pair with the crystalline water-proofing agent.

Table 19. Curing regimes

Sample ID	Mixture #	Curing Method
A	1	Air Cured
B	1	Plastic 7-days
C	2	
D	4	
E	1	Plastic 28-days
F	1	Soybean oil
G	1	White pigment
H	1	Non-film evap.
I	3	ret.

Sample Preparation and Curing

The concrete was mixed according to ASTM C192 (2003) and the 150 mm x 150 mm x 525 mm (6 in. x 6 in. x 21 in.) beams were placed in order to simulate typical field placement and

finishing operations. Two sample beam molds at a time were filled with fresh concrete using a shovel and rough finished to approximately 25 mm (1 in.) above the mold. An electrically driven roller-screed was then used for final compaction and finishing as shown in Figure 35. The roller-screed rotates in the direction opposite to forward movement, which provides compaction and orients the CA particles along the surface. Immediately after finishing, the samples were moved outside and the appropriate curing method applied. Figure 36 shows the samples before applying curing compound. Initially, the white pigment and soybean oil emulsion look similar, but as the water evaporates from the soybean oil the oil penetrates into the concrete, producing a slightly darker color than the control.



Figure 35. Finishing using a roller screed



Figure 36. Fresh concrete with no curing compound

The beams were demolded after 24 hours and transferred to a site designed to simulate field curing conditions. An area approximately 100 cm (42 in.) by 150 cm (60 in.) by 36 cm (14 in.) was excavated and filled with 20 cm (8 in.) of a drainable aggregate base (Figure 37). Beams

were placed on the base and the edges filled with aggregate, as shown in Figure 38. After 28 days, the beams were removed and tested for flexural strength and abrasion.



Figure 37. Aggregate base at test location



Figure 38. Initial beam curing

All beams were cast and cured in July when the high temperature was 26°C (79°F) and average wind speed was 7 kilometers per hour (kph) (4.4 miles per hour [mph]). The date of placement was scheduled to represent extreme summer placing and curing conditions. During the first seven days, which are critical to concrete curing, the average maximum air temperature was 32.3°C (90.1°F). The initial moisture deficit (potential evapotranspiration [ET] minus the actual precipitation) was 4.57 cm (1.80 in.) and increased to 11.2 cm (4.41 in.) over the entire 28-day curing period. Even though the relative humidity was high (~75%), drying conditions were caused by a substantial imbalance between evaporation and precipitation. Table 20 provides the average climatic data for both the first seven days and the entire curing period.

Table 20. Climatic data for curing duration (ISU 2006)

	First 7 days	Entire 28 days
Avg. Max Air Temp, °C (°F)	32.3 (90.1)	30.2 (86.4)
Avg. Min. Air Temp, °C (°F)	18.8 (65.9)	19.1 (66.3)
Avg. 4" Soil Temp, °C (°F)	28.8 (83.9)	28.0 (82.4)
Avg. Max Wind Speed, kph (mph)	24.6 (15.3)	23.7 (14.7)
Avg. Wind Speed, kph (mph)	9.0 (5.6)	8.7 (5.4)
Precipitation, cm (in.)	0.13 (0.05)	5.21 (2.05)
Potential ET, cm (in.)	4.70 (1.85)	16.41 (6.46)
Relative Humidity (%)	75.4	76.7

Results and Discussion

The soybean oil emulsion, when first applied, was milky white in color, and as the water evaporated the oil penetrated the concrete surface. After one day, the only indication of application was a slightly darker concrete color. The non-film forming evaporation retardant was diluted with water according to the manufacture's specifications and surface applied. The consistency was similar to water and a majority of the curing compound permeated the sample, whereas the white pigment and soybean oil remained on the surface particles.

The control mixture design (Mixture #1) was placed in 18 beams, finished two at a time, and then surface treatments were randomly applied; the modified mixture designs (Mixtures #2, #3, and #4) were also placed at that time. Results of the concrete flexural strength along with porosity and unit weight are shown in Table 21. The unit weight and porosity were determined from core samples extracted from the beams after Modulus of Rupture (MOR) testing and represent an average of three test specimens per beam and the flexural strength from two beams. The core samples had a diameter of 75 mm (3 in.) and an approximate length of 150 mm (6 in.). The porosity values ranged from 17.5% to 23.1% for the control mixture (samples A, B, E, F, G, and H) and increased to 27.3% for the mixture containing fibers (D). For the mixtures not containing fibers, flexural strength generally followed a similar trend as the porosity, ranging from 1.10 MPa (162 psi) to 2.40 kPa (345 psi).

Table 21. Beam test results

Sample ID	Mixture ID #	Curing Method	Beam Porosity	Beam Unit Weight	Avg. Flexural Strength
			(%)	kg/m ³ (pcf)	MPa (psi)
A	1	Air cured	23.1	1,820 (114)	1.80 (264)
B	1	Plastic 7 days	17.5	1,910 (120)	2.35 (344)
C	2		22.9	1,780 (111)	1.95 (286)
D	4		27.3	1,830 (114)	2.20 (319)
E	1	Plastic 28 days	17.8	1,930 (121)	2.40 (345)
F	1	Soybean oil	21.3	1,865 (117)	1.95 (286)
G	1	White pigment	16.7	1,890 (116)	1.70 (244)
H	1	Non-film evap.	19.7	1,820 (113)	1.90 (273)
I	3	ret.	21.5	1,7501 (109)	1.10 (162)

The concrete abrasion results for the control mixture cured under different conditions (samples A, B, E, F, G, and H) are shown in Figure 39, where an abrasion index of 100% represents the control mixture design allowed to cure in the field without any internal or surface-applied curing methods (Air Cured, Sample A). A majority of mass loss was paste removed from the aggregate surface followed by abrasion of the aggregate with occasional removal of individual whole aggregate pieces. The average abrasion for the control mixture (A) was 7.37 g (0.02 lb) per test. The mixtures cured under plastic had the best abrasion resistance, between 55% (E) and 64% (B) of the control. Of the surface-applied treatments, the soybean oil emulsion (F) had the best abrasion index at 82%, followed by the standard white pigment (G) at 86%, and non-film forming evaporation retardant (H) at 91%.

The range of unit weight values for Mixture #1 was within the bounded variability evaluated during the reference testing phase. Therefore, any differences in abrasion can be attributed to curing effects and not variability in unit weight. Since the Mixture #1 samples were placed at the same fresh unit weight and the only difference between the samples was the method of curing, the hardened oven-dry unit weight can be used to represent the curing effectiveness. More complete curing results in more water chemically bound in cement hydration, resulting in a higher unit weight. For Mixture #1, the samples cured under plastic (Samples B and E) had the highest unit weights corresponding to the best abrasion resistance. The least effective curing methods were the air-cured samples and the samples cured with the non-film forming evaporation retarder. These two methods produced the lowest unit weights (Samples [A] and [H]) and had the poorest abrasion resistance (Table 21 and Figure 39).

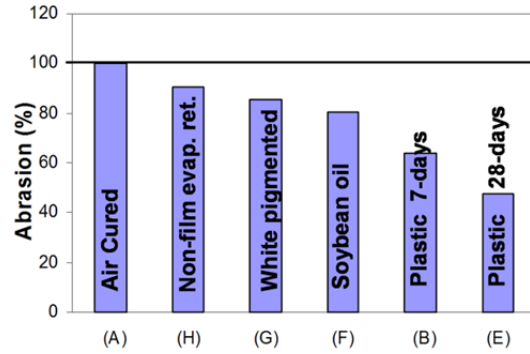

Figure 39. Effect of curing regime on control concrete mixture properties

The concrete abrasion testing results for the air-cured control (A) along with the modified mixture designs (samples C, D, and I) are shown in Figure 40. When cured under plastic for seven days, the mixture containing 100% portland cement (C) had slightly better abrasion resistance than the mixture containing 15% fly ash (B), although the durability increased for the fly ash mixture when cured under plastic for 28 days (E), as compared to samples (C) and (B). The mixture containing fibers (D) had similar abrasion to the control mixture (A), although the porosity was 7.9% higher than the average for the control mixtures. The lowest performing mixture contained the internal crystalline water-proofing agent with the surface-applied non-film forming evaporation retardant (I) and had the highest AI at 219.

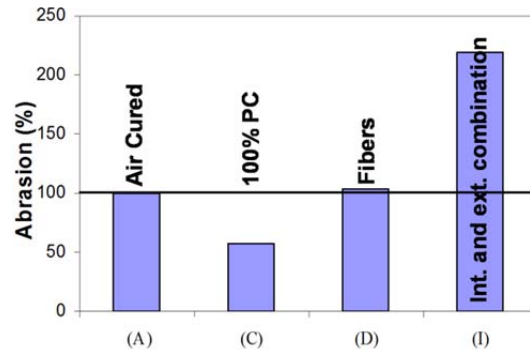

Figure 40. Modified mixture response to curing regime

The flexural strength for the air-cured control mixture was 1.80 MPa (264 psi). The mixtures covered in plastic had the highest strength, with the greatest increase over the control for the beams cured under plastic for 28 days. The maximum flexural strength was 2.40 MPa (345 psi), produced by the specimens cured under plastic for 28 days. However, there was only a slight increase in flexural strength between the samples cured under plastic for seven days (2.35 kPa, 344 psi) and 28 days (2.40 kPa, 345 psi). Of the surface-applied curing methods, the soybean oil emulsion produced the greatest increase in strength over the control at 1.95 MPa (286 psi).

Of the modified mixtures cured under plastic for seven days, the only mixture that produced a significant decrease in strength was the internal crystalline water-proofing agent with the non-

film forming evaporation retardant (I), which reduced flexural strength by 40% from the control. The mixture containing fibers and cured under plastic for seven days (D) produced an increase in flexural strength of 21% over the control, even though the unit weight was lower corresponding to a higher porosity. Fibers have previously been shown to increase tensile strength of pervious concrete (Kevern et al. 2008b).

Conclusions from the Curing Evaluation

From this task, the following conclusions and recommendations can be made:

1. The samples cured under plastic had the best abrasion resistance and highest flexural strength. There was no significant difference in flexural strength between samples cured under plastic for seven or 28 days, although abrasion resistance did increase with the duration of curing.
2. Soybean oil has the potential to be used as an effective curing compound. In this study, the soybean oil emulsion produced the best surface durability and increase in flexural strength of the surface-applied curing agents.
3. The “birds nest effect” caused by the fibers increased the porosity by 7.9% and yet produced a flexural increase of 21% over the control without significantly impacting surface abrasion.
4. The rotary-cutter surface abrasion ASTM C944 method has the ability to differentiate between curing methods, allowing relative surface durability comparisons.

CHAPTER 7. EFFECT OF DEICERS ON PERVIOUS CONCRETE DURABILITY

Introduction

Portland cement pervious concrete is increasingly used in the United States to help manage stormwater runoff and to improve water quality. It has been used in other countries as a roadway material for reduced water splash, surface heat, and traffic noise.

In cold weather regions, deicers are applied to a pavement surface to help prevent icing. The relatively high permeability of PCPC allows melting water to drain into the stormwater system, thus reducing the potential for surface icing due to ponded water. Sand is sometimes applied to pavement in the event that the temperature drops below a level at which deicers can prevent freezing. Deterioration of concrete is often rapid on roadways due to heavier deicer applications, when compared to those with less deicer applications such as parking lots and sidewalks (Dubberke and Marks 1985).

Deicers can aggravate damage to pavements by increasing the level of moisture saturation and the osmotic pressure in concrete as well as due to the increased volume of salt crystallization during drying (Kosmatka et al. 2002). Damage and degradation can also be caused by the interaction between concrete materials and deicing chemicals, which result in leaching and the decomposition of cement hydration products. Traditional pavements can be protected from deicer damage by the use of surface sealers or by decreasing the concrete permeability. Portland cement pervious concrete, on the other hand, does not have surfaces that can be sealed, but it may drain the water away and not become fully saturated most of the time in the field.

Currently, evaluation of concrete resistance to deicing chemical damage is commonly performed according to the standard test method ASTM C672 (2003). This standard test method requires that a reservoir be created at the top of a concrete sample so that a deicing chemical can be ponded on the surface of the sample and then placed in a freeze-thaw environment. Because of the nature of PCPC, deicing chemicals cannot be ponded at the top of the sample as they will simply permeate through it. Therefore, fully immersing the sample in deicing solution under freeze-thaw conditions is often employed, although it does not accurately represent typical field conditions. The fully immersed test method can cause much more severe deterioration of the concrete than would be expected.

This chapter presents research to evaluate the resistance of the two freeze-thaw durable PCPC mixtures developed in Chapter 5 to common deicers used by state DOTs. The evaluation was carried out through a freeze-thaw test of PCPC samples in the selected deicer solution. The weight loss, strength loss, and surface condition of the PCPC were assessed.

Materials and Mixture Proportions

Concrete Materials

The aggregate used in the study was a 3/8-inch crushed granite with an oven-dry specific gravity of 2.65, absorption of 0.59%, and 18% passing the No. 4 sieve. The sand was a typical ASTM C33 graded concrete river sand with a fineness modulus of 2.9, specific gravity of 2.62, and absorption of 1.1% (ASTM 2003). Cementitious binders included Type II portland cement, grade 120 ground granulated blast furnace slag, and class C fly ash. All mixtures contained two types of fibers each at equal dosages, a fibrillated polypropylene graded-length fiber and a cellulose micro-type fiber. The standard admixtures included a polycarboxylate HRWR, synthetic AEA, and HS admixture. Two versions were produced, one with an additional VMA and the second with a latex-based additive originally used for cement block manufacturing. For more information on the mixture specifics, see Chapter 5.

Deicing Chemicals

Two common chloride deicing chemicals and one acetate deicing chemical were considered in the present study: sodium chloride (NaCl), calcium chloride (CaCl₂), and calcium-magnesium acetate (CMA). The three deicing chemicals were selected based on their wide applications and ease of access.

All deicing chemicals were applied at a 9% concentration, by weight. The chemical concentration was selected by trial to maximize the potential chemical interaction between deicing chemical and paste or concrete and to ensure that the samples would freeze under the designed freeze-thaw conditions.

Sample Preparation and Test Methods

Concrete was prepared using a rotating-drum mixer. First, to the aggregate in the mixer, two-thirds of the water and AEA were added and mixed until foam was observed. Then the binders and water with HRWR, VMA or latex polymer admixture, and an HS were added. Finally, the concrete was mixed for three minutes, covered and allowed to rest for three minutes, and then mixed for an additional two minutes before casting according to ASTM C192 (2003).

Fifteen pervious concrete samples of both mixture types (latex and nonlatex) were prepared for each deicing chemical. The samples had a size of 4 x 4 x 4 inches (100 mm x 100 mm x 100 mm).

All pervious concrete samples were placed by lightly rodding 25 times in three layers to ensure uniform compaction in each lift. The rodding was performed to evenly distribute the porosity and not to penetrate the underlying layer. This procedure was designed to uniformly compact the specimens without consolidation. The samples were cured according to ASTM C192 in a standard curing room for 28 days, removed, and allowed to air dry for a minimum of 24 hours.

The concrete sample was then placed in a -18°C (0°F) freezing environment for 18 hours followed by a 23°C (73.4°F) thawing environment for six hours. This cycle was repeated daily, while ensuring periodically that the surface of the specimen remained covered in the ponding solution.

Since the standard test method (ASTM C672) is unsuitable for determining the resistance of pervious concrete surfaces exposed to deicing chemicals, no deicing chemical can be ponded atop the sample due to its pervious nature. To overcome this, two sample exposure conditions were developed and implemented, and they are the saturated test method and the drained test method.

Saturated Test Method

Under this exposure condition, concrete samples were soaked in the deicing chemical solutions the entire time prior to testing. This test method (Table 22) replicated a worst-case scenario, or “severe application,” as the pervious concrete samples were entirely immersed in deicing solution. This significantly increased the surface area of the sample in contact with the deicing chemicals and created a greater potential for interaction between the deicing chemicals and the concrete paste.

Table 22. Saturated test method—Experiment regimen

Sample	Chemical	No. of Samples	Testing Time (Cycles)	
			Weight Loss	Compressive Strength
<i>Nonlatex Modified PCPC</i> (4-inch cube)	Distilled water	12 for each chemical	6, 12, 18, 24,	18, 36, 54
	NaCl		30, 36, 42, 48,	
	CaCl ₂		54	
<i>Latex Modified PCPC</i> (4-inch cube)	Distilled water	12 for each chemical	6, 12, 18, 24,	18, 36, 54
	NaCl		30, 36, 42, 48,	
	CaCl ₂		54	
	CMA			

In this test, a set of three samples were placed inside 4.5 in. x 4.5 in. x 13 in. containers and each container was filled with a specific deicing solution or distilled water so that all samples were entirely immersed. The containers were then placed in a freeze-thaw chamber calibrated to have a temperature range between -18°C (-0.4°F) and 10°C (50°F). The tank was filled with containers until it contained a total of 24 samples with 12 samples from each mix type. The freeze-thaw cycles would alternate once the full cycle of the temperature range had been achieved, each taking two hours to be completed. Thus, one complete freeze-thaw cycle took a total of four hours and testing was concluded after nine days, the completion of 54 cycles.

After every six cycles, the samples were removed from their container for mass measurement. First, the samples were placed in a static tub of tap water and loose particles on the samples were gently removed by hand. The samples were then laid on towels to dry to SSD conditions. If the samples were not too friable, they were blotted dry with additional towels to speed up the drying process. After 20–25 minutes of drying, the samples were weighed to the 0.1 gram.

At every 18 cycles, three samples of each mix type were removed for compressive strength measurement, conducted in accordance with a modified ASTM C109 procedure (C109 2003). The deicing solution in the containers was changed every 12 cycles (48 hours).

Drained Test Method

This test method (Table 23) was developed to replicate a “realistic application” of deicing solution onto pervious concrete in a laboratory setting. This method was identical to the first test method, except the deicing chemical was allowed to slowly drain from the freeze-thaw containers into a lower reservoir while the samples were frozen. Holes were drilled in the base of each container such that all of the deicing solution would drain within 30 minutes with a flow rate of 5.85 in.³ per minute.

Table 23. Drained test method—Experiment regimen

Sample	Chemical	No. of Samples	Testing Time (Cycles)
			Weight Loss
<i>Nonlatex Modified PCPC</i> (4-inch cube)	Distilled water CaCl ₂	12 for each chemical	6, 12, 18, 24, 30, 36, 42, 48, 54
<i>Latex Modified PCPC</i> (4-inch cube)	Distilled water CaCl ₂	12 for each chemical	6, 12, 18, 24, 30, 36, 42, 48, 54

The deteriorative effects would be caused by the residual deicing solution left on the sample as would be seen in the field. After every six cycles, the samples were removed from their container for mass measurement. The same drying procedures used in the first test method were followed, and the samples were weighed to the nearest tenth of a gram. As previously noted, the deicing solution in the containers was changed every 12 cycles (48 hours).

The rate of mass loss was measured, and the results were compared with those from the saturated test method.

Results and Discussion

Saturated Test Method (Severe Deicing Chemical Application)

Mass Loss—Figure 41 represents the overall mass loss of the PCPC samples subjected to different deicing solutions under freeze-thaw cycling. In distilled water, both nonlatex and latex-modified PCPC had little or minimal mass loss. When subjected to a deicing chemical solution, the mass loss of PCPC became significant. Among the three deicing chemicals used, the CaCl_2 solution resulted in the highest mass loss and the CMA solution resulted in the least mass loss. The mass loss for the latex-modified PCPC was considerably higher than that of nonlatex PCPC, which indicates that a chemical or physical reaction might occur between the latex-modified concrete with the deicing chemicals. It is possible that the latex film formed in the concrete might become brittle and lose its bond to cement paste and aggregate during the freeze-thaw cycles. Since the samples had been cured for 28 days in a wet condition before the scaling test, some latex particles might still be in a suspension state. When subject to the deicing chemicals, some chemical, such as CaCl_2 , could make the latex coagulated, thus damaging the structure of latex film in the concrete. Further study is needed to investigate the damaging mechanism of a deicing chemical to latex-modified PCPC.

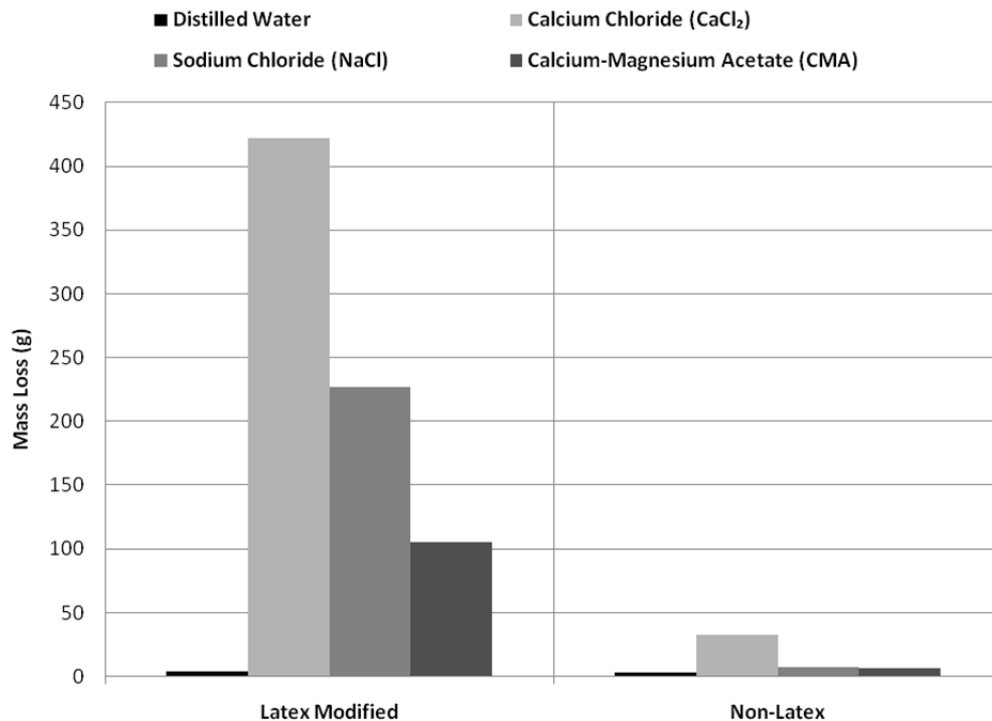

Figure 41. Mass change of PCPC after freeze-thaw cycling at 54 cycles

Figure 42 and Figure 43 illustrate the progress in weight loss of PCPC with the number of freeze-thaw cycles. It was observed in Figure 42 that the rate of mass loss was gradual for nonlatex samples subjected to NaCl, CMA, and distilled water, but it decreased with time for the

samples subjected to CaCl_2 . Figure 43 shows that the rate of mass loss of latex-modified PCPC differed for each deicing solution. The samples in the three deicing solutions— NaCl , CaCl_2 , and CMA—all exhibited a higher rate of mass loss than nonlatex samples but decreased rate of mass loss with time. The loss of aggregate particles from the samples may be attributed to the higher rate of the concrete mass loss (Figure 44).

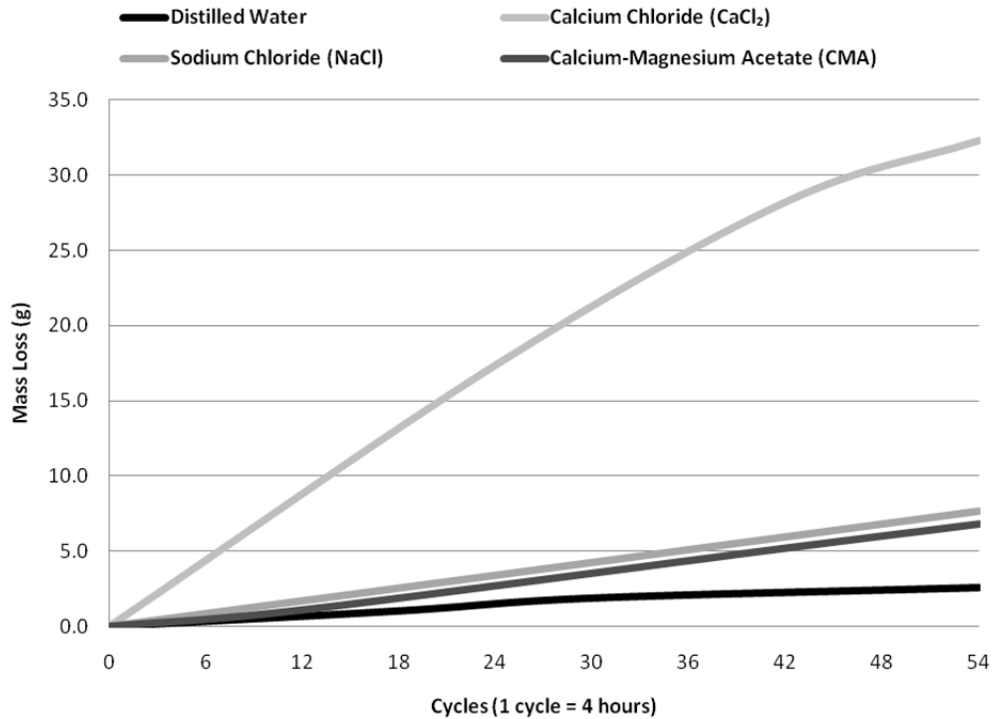

Figure 42. Mass loss of nonlatex PCPC with freeze-thaw cycles

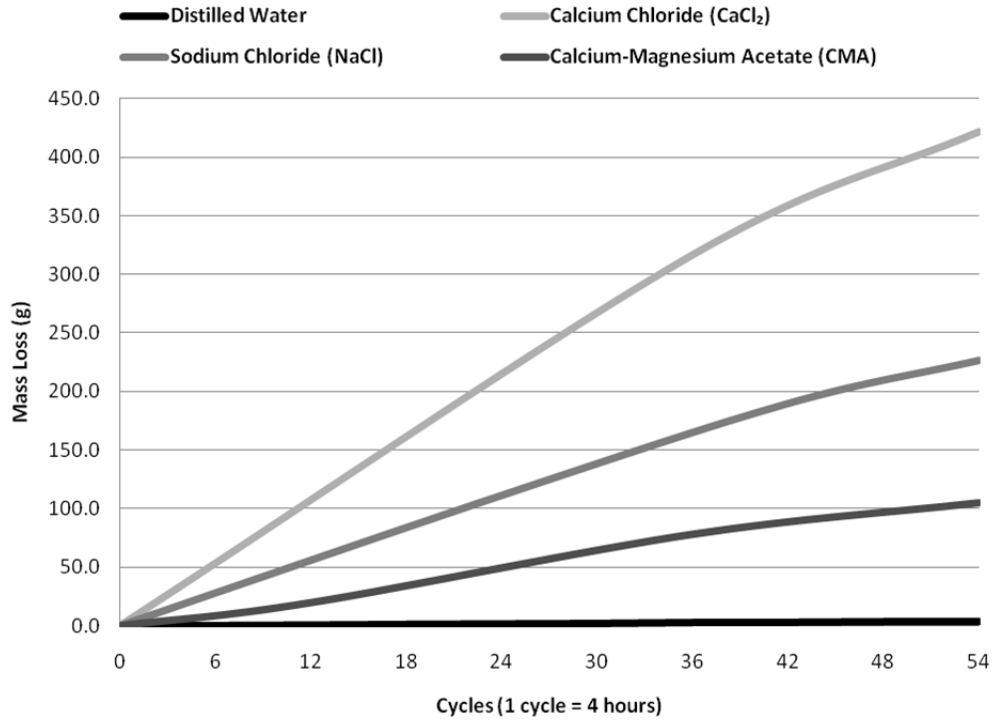
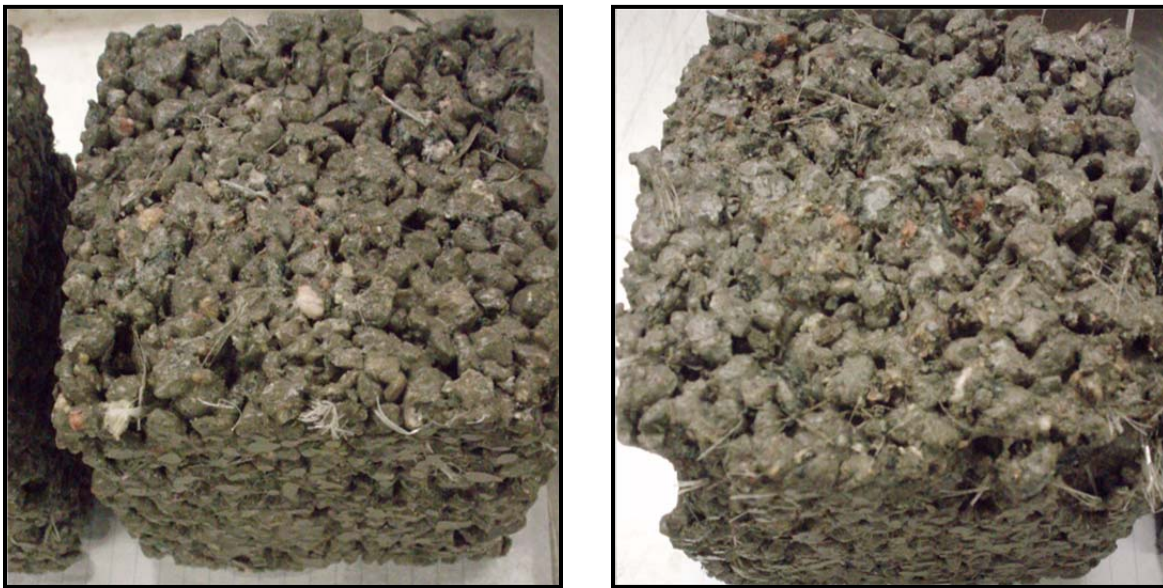

Figure 43. Mass loss of the latex-modified PCPC with freeze-thaw cycles



(a) Nonlatex Pervious Concrete

(b) Latex-Modified Pervious Concrete

Figure 44. PCPC samples after 54 freeze-thaw cycles in calcium chloride solution

Although both mixes were designed with a target of 25% void ratio, it was found that when compared to the nonlatex PCPC, the latex-modified PCPC had lower strength (Schaefer et al. 2006), which may be related to its lower scaling resistance.

Compressive Strength

Figure 45 represents the compressive strength of the nonlatex pervious concrete samples subjected to different deicing solutions under freeze-thaw cycling. All samples experienced a loss in strength with increased freeze-thaw cycles. The strength loss of the samples immersed in deicing solution at 54 cycles, from the highest to the lowest, was CaCl_2 , NaCl , and CMA. However, the degree of the strength loss of samples subjected to the deicing chemical was not significantly different from that of samples subjected to the distilled water. This suggests that the sample damage might occur only on the surface layer of the concrete, which resulted in a noticeable mass loss but did not considerably influence the internal concrete materials, shown by the sustained concrete strength.

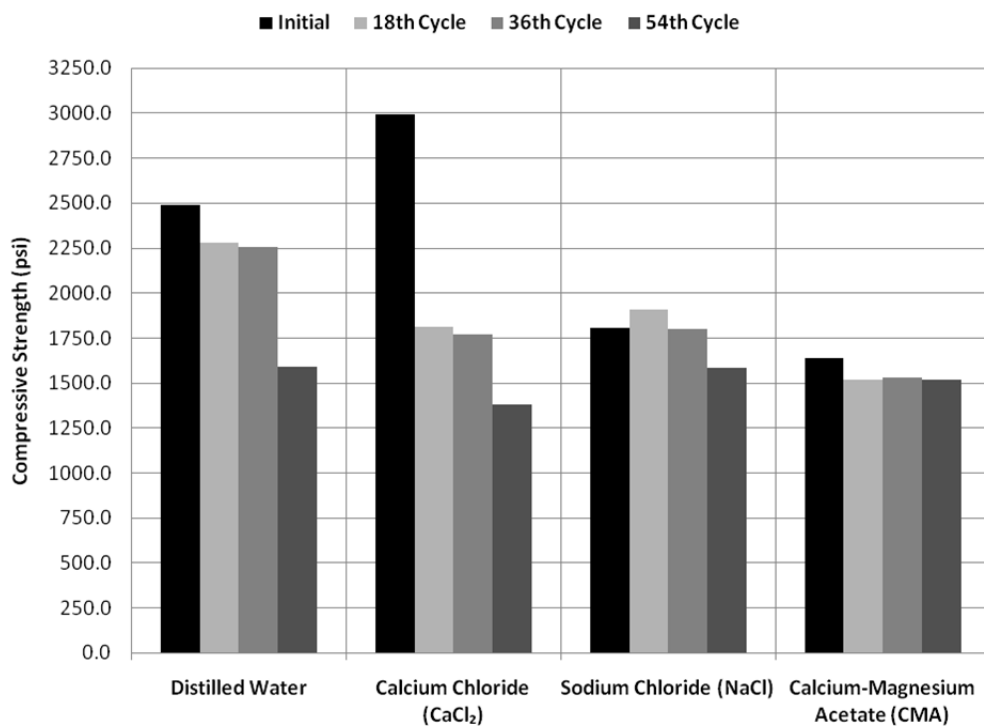

Figure 45. Compressive strength of nonlatex pervious concrete

Figure 46 represents the compressive strength of the latex-modified pervious concrete samples subjected to different deicing solutions under freeze-thaw cycling. Samples exposed to deicing solutions showed strength less comparable to the water-immersed samples, but they all experienced a loss in strength, although it was observed that the strength of the CMA samples remained relatively consistent. The strength loss of the samples immersed in a deicing solution at 54 cycles, from the highest to the lowest, was CaCl_2 , NaCl , and CMA.

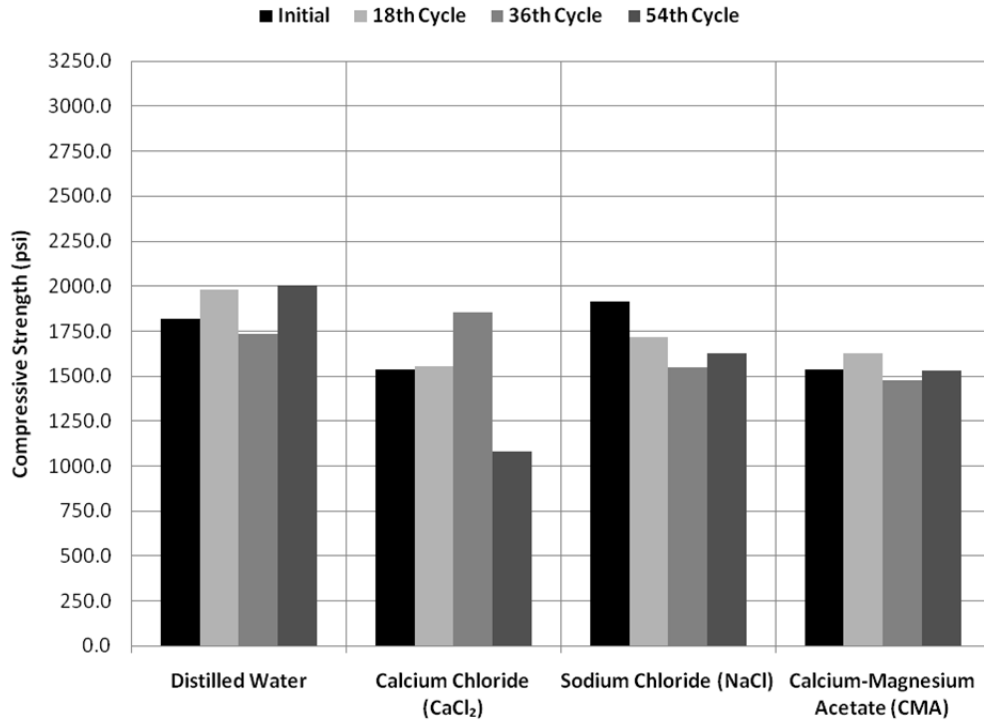

Figure 46. Compressive strength of latex-modified pervious concrete

Drained Test Method

Based on the mass change and compressive strength results from the first test method, CaCl₂ was determined to have the most deteriorative effects on both mix types. Figure 47 represents the mass change comparisons between both testing methods (severe and realistic applications) of the pervious concrete samples subjected to CaCl₂ deicing solutions under freeze-thaw cycling.

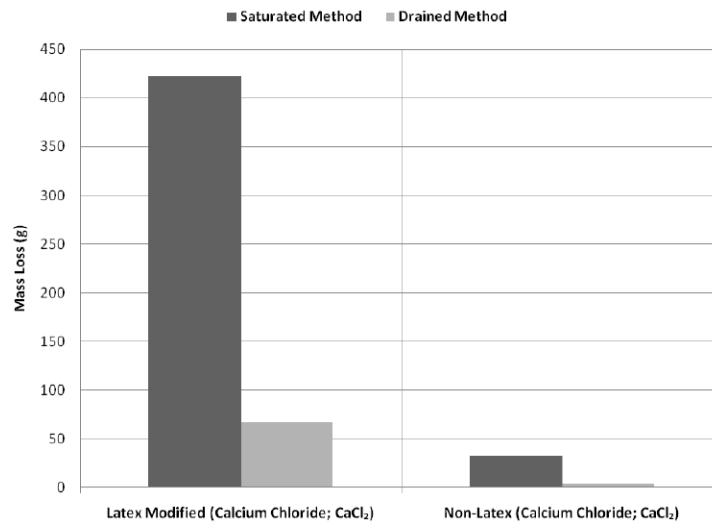

Figure 47. Mass change comparison of both deicer application methods at 54 cycles

It was found that the rate of deterioration for both mix types drastically decreased between the two test methods. For the latex-modified pervious concrete it was found that the realistic application was 13 times less deteriorative than the severe application, while the realistic application on the nonlatex pervious concrete was found to be 18 times less deteriorative than the severe application. Based on these results, it can be concluded that ASTM C672 may not be appropriate for replicating the effects of deicer on pervious concrete. Further field testing should be conducted to confirm this.

Conclusions from Deicer Testing

From testing presented in this chapter, the following conclusions and recommendations can be made:

1. Both the saturated and drained test results indicate that PCPC with latex polymer had much higher mass loss than the PCPC without latex polymer, regardless of the type of deicing chemicals.
2. For a given concrete mixture, CaCl_2 caused much more severe damage, evaluated by the surface condition, mass loss, and compressive strength of the concrete, when compared with NaCl and CMA , regardless of the deicer application methods. More attention should be paid in selecting deicing chemicals in PCPC practice.
3. The saturated deicer application method as followed by ASTM C672, representing the most severe condition, provided much higher mass loss of tested concrete (latex-modified and nonlatex concrete subjected to CaCl_2 solution) when compared with a modified, more realistic drained method.

CHAPTER 8. CLOGGING EFFECTS FOR MAINTENANCE PRACTICES

Introduction

Clogging of PCPC leading to potential problems in serviceability has been regarded as one of the primary drawbacks of all permeable pavement systems. Understanding the clogging issue is essential for estimating the quality of pervious concrete pavement and delineating further maintenance. The objective of this task was to examine the clogging effect of pervious concrete at different design void ratios subjected to three types of sedimentation materials and to provide a quantitative evaluation in terms of permeability reduction. Additionally, comparisons of rehabilitation methods were examined in terms of permeability recovery of clogged specimens. A maintenance schedule based on laboratory clogging test results could be used as a reference guide for pervious concrete pavement maintenance in the field.

Because of the open structure, pervious concrete acts as a filter, retaining sediments, organics, chemicals, and other contaminants flushed through the PCPC during a precipitation event. Up to 75% of total urban contaminant loads can be reduced using PCPC pavements (Mississippi Concrete Industries Association 2002; Othman and Hardiman 2005). While such removal makes PCPC a valuable stormwater management tool under Environmental Protection Agency Storm Water Phase II regulations, the retention of contaminants may lead to clogging of the PCPC system.

Clogging has been regarded as a primary cause of failure, reducing the effective service life and impeding the widespread use of pervious concrete pavement (U.S.EPA 1999; ACI 2010). Clogging in permeable pavements has been studied in laboratory and field environments. Key references include Tan et al. 2001, Ferguson 2005, Othman and Hardiman 2005, Haselbach et al. 2006, Bean et al. 2007, Mata 2008, Pezzaniti et al. 2008, Deo et al. 2009, Chopra et al. 2010, and Haselbach 2010. An extensive review of the literature was presented by Tong (2011). The following are important points that emerge from the literature related to clogging of pervious concrete pavements:

1. Construction runoff and vehicles should be prevented from running on pervious concrete pavement. Ideally, permeable pavement should be constructed after the adjacent areas are well finished and have established ground cover.
2. The clogging potential of pervious concrete depends on the gradation of sedimentation materials and mixed aggregates, pore size, initial porosity and sediment type.
 - When the sediment particle size is similar to the pore size of pervious concrete, the clogging potential is highest.
 - A narrower particle size distribution of mixed coarse aggregates retains the better clogging resistance and higher residual permeability; blended mixed aggregates have more clogging potential.

- Different types of sediments cause different clogging effects on pervious concrete based on the deposited patterns and locations.
 - Clogging reduces the permeability of the specimen with void ratios from 23% to 31% more significantly compared to the specimen with the void ratio about 33% higher.
3. Sedimentation effects may significantly reduce permeability but have a negligible effect on storage capacity of pervious concrete.
 4. Traditional cleaning methods show very limited recovery on finer sediments but better efficiency on coarser sediments.
 5. The combination of vacuuming, sweeping, and pressure washing shows the best efficiency based on empirical evidence and experience.
 6. An additional one inch of subbase is recommended to account for clogging in the hydrological design of pervious concrete.

Although considerable work has been done, a more comprehensive study on clogging effects by considering the effects of void ratios, sedimentation types and cleaning methods is warranted. This study was undertaken to accomplish the following:

- Identify and analyze the effects of various void ratios on the change in permeability coefficients of pervious concrete being exposed to clogging
- Determine the deposition patterns and severity of different sedimentation materials on clogging effect
- Determine the efficiency and working mechanisms of three rehabilitation methods under different clogging conditions and for various void ratios of PCPC specimens

To meet these objectives, a comprehensive testing matrix was developed wherein three variables including three types of sediment materials, three designed void ratios, and three selected cleaning methods, are considered. The results show that permeability reduction magnitude as well as rate and permeability recovery by rehabilitation are significantly affected by sediment types, void ratios of specimens, and selection of rehabilitation methods. The results provide a quantitative evaluation of the clogging effect of pervious concrete and the comparison of tested rehabilitation methods in terms of permeability recovery. The conclusions based on the testing results may be used as a reference for clogging resistance design of pervious concrete.

Laboratory Experimental Plan

The objective of the experimental work was to examine the clogging effect on pervious concrete of different design void ratios subjected to different sedimentation materials, and to provide a quantitative evaluation of the clogging effects in terms of permeability reduction. The design principle of the experimental study was to simulate the in-place field clogging of pervious

concrete in the laboratory. Previous tests on clogging were conducted by Deo et al. (2009), Haselbach et al. (2006), Joung and Zachary (2008), Mata (2008), Pezzaniti et al. (2008), and Tan et al. (2001). The clogging test methods, sample preparations, and sedimentation amounts used are slightly different for each of these studies. However, most of the experiments were conducted based on the use of falling head permeability tests and determination of the reduction in permeability as clogging occurred.

The concrete mixture used for the clogging tests was the mixture developed in Chapter 5 containing the polymer admixture. The original mixture designed for 22.5% voids can be found in Table 16. Unit weight of the selected mixture was modified to achieve the various void contents presented herein.

The clogging tests were based on conducting laboratory permeability tests through pervious concrete specimens in which sediment is introduced during the permeability test. Two types of tests were developed—Case A for the typical in-service condition and Case B for unexpected clogging events—and are described below. A clogging cycle is defined as follows. For each cycle, an equal amount of clogging material is spread evenly on the testing specimen top, and the permeability is measured by allowing the water to flow through the specimen along with the suspended clogging material within. This procedure is referred to as clogging. After the water was completely drained, a tested rehabilitation method was selected to clean the clogged specimen. After cleaning, the permeability test was conducted again by allowing pure water flow through this “cleaned” specimen, and permeability was recorded. This procedure is referred to as cleaning. Each clogging cycle includes a clogging and a cleaning operation.

The soils used for sediment in this study were selected to have the most significant effects on reduction of exfiltration, and a fairly large range of particle size distribution was studied. In addition, a soil with both coarse and fine particles will likely be retained on the pervious concrete, with the larger size remaining on or in the surface region and the finer particles susceptible to transport through the pavement vertically (Ferguson 2005). The three soils used in this study are shown in Figure 48. Further information on the soils can be found in Tong (2011).



Figure 48. Three sediment materials used: sand (left), silty clay (middle), and silty clay sand (right)

Three cleaning procedures were used. Pressure washing, in which a “power head cone nozzle” concentrated water in a narrow cone and directly sprayed on the sample surface with a pressure of 14.5 Map (1,000 psi), was one of the procedures. Vacuuming was effected by a 4.85 kilowatts (6.5 horsepower) wet/dry vacuum sweeper. The sealed pressure was 4 psi, which is smaller than commonly used for vacuum sweeping pressures on in-place pavement. For each sample, approximately 60 seconds of vacuuming was applied. A combined procedure was also used in which the pressure washing method was followed by vacuum sweeping.

Case A: Small Sedimentation Load

A small sediment load was used for the Case A type testing, consisting of 0.22 lbs (0.1 kg) of total sediments. To simulate 20 years of effective service life with continuous amounts of small sediment loading, 0.22 lbs of sediment was divided into 20 cycles of sediment addition. Thus, for each clogging procedure run, the amount of sediments was approximate 0.01 lb. The initial permeability of the unclogged specimen was determined, then 0.01 lbs of sediment was spread evenly on the specimen’s surface and the permeability test was conducted by allowing the water to flow through the specimen along with the clogging materials on the surface. The process was repeated up to 20 times for each sample using one type of sediment.

Case B: High Sedimentation Load

For Case B trials, a greater amount of sediment was used and each clogging cycle was followed by one of the three cleaning/rehabilitation methods. A total of 1.76 lbs (0.82 kg) of soil sediments was used to simulate the total sedimentation load during 20 years of service life. Therefore, in each clogging cycle, 0.088 lbs of clogging materials, which is one-twentieth of the total, was spread evenly on the specimen top, and water was allowed to flow through. Following each clogging cycle, a selected cleaning method was applied and permeability was measured

again. This procedure was conducted up to 20 times for each specimen to examine the effects of sedimentation and cleaning efficiency.

Test Results and Analysis

Three replicate samples were used for each design porosity, sediment type, and sediment loading (Case A or B). The Case B sediment loading also considers three types of cleaning. Information on the size, fresh density, and porosity for each specimen can be found in Tong (2011). The results for the Case A loading are presented first, followed by the results for the Case B loading.

Case A: Small Sedimentation Results

The changes in permeability of specimens under the sedimentation from three types of sedimentation materials are shown in Table 24 and the results are discussed below based on sediment type. The initial permeability of the samples in these tests shows expected patterns in which the initial permeability increases as the porosity changes from 15% to 20% to 25%. The specimens are grouped by sedimentation materials and by design porosity. The residual permeability for each specimen (the permeability at the end of 20 cycles of clogging) and the decrease in permeability as a percent are shown for each specimen and then averaged for each group of specimens. As the effects of the fine particles were negligible for permeability reduction, silty clay sedimentation tests were not conducted on the highest porosity samples.

Silty-Clay or “Fine Particles” as Sedimentation Materials

When silty clay or very fine particles were used as sedimentation materials, the clogging effect was fairly negligible (less than 1%) in terms of permeability coefficient reduction for specimens at 15% and 20% void ratios. No tests were run for 25% porosity based on the results of the 15% and 20% porosity. The results in Table 24 show that the fine particles caused little reduction in permeability of the pervious concrete. These results indicate that the fine particles (with sizes passing the No. 200 sieve [75 μm]) were carried through the pore spaces of the concrete during the test and, indeed, the sediment was retained by the filter fabric layer at the end of the samples. Such a buildup of a fine deposition layer between the pavement layer and filter fabric layer could lead to a lower system permeability; however, this did not occur in these tests. For the concrete itself, the effect of silty clay sediment is fairly negligible.

Sand as Sedimentation Materials

When sand was used as the sedimentation material, a significant decrease of permeability occurred to all three groups of specimens. The results in Table 24 show that average decreases in permeability of 65%, 86%, and 90% occurred for the 15%, 20%, and 25% porosity tests, respectively. The average decrease increased with increasing porosity as the sand had a greater effect on the higher porosity concrete. It is interesting that the average residual permeability was in a small range from 118 to 143 in./hr. This indicates that regardless of the initial porosity, the specimens tended toward a similar residual permeability.

The amount of sediment flowing through each specimen was carefully tracked. Less than 3% of the amount of applied sediment materials passed through any one specimen during testing. This indicates that the sand sediments were either retained on the surface of the sample or within the specimens. In the case of applying sand as the sediment material, the void size of this mix design caused the pervious concrete to act as a filter to eliminate the solids within the water. This is confirmed by the reduction in permeability results shown in Table 24.

Table 24. Changes in coefficient of permeability in specimens at different states of the Case A sedimentation test

Design Porosity (%)	Sedimentation Materials	Specimen	Initial Permeability Coeff. (in./hr)	Residual Permeability Coeff. (in./hr)	Decrease of Permeability after Sedimentation (%)	Average Residual Permeability (in./hr.)	Average Decrease of Permeability (%)	
15	Sand	S-1-1	333.7	118.6	64	119	63	
		S-1-2	250.3	112.5	55			
		S-1-3	421.8	126.4	70			
		20	S-2-1	794.5	107.2	87	118	86
			S-2-2	748.3	118.6	84		
			S-2-3	948.3	128.4	86		
		25	S-3-1	1607.2	142.6	91	143	90
			S-3-2	1408.2	138.6	90		
			S-3-3	1374.6	147.3	89		
15	Silty clay	C-1-1	458.2	457.3	0	411	0	
		C-1-2	421.6	419.5	0			
		C-1-3	358.4	357	0			
		20	C-2-1	587.2	587.6	0	600	0
			C-2-2	614.3	613.2	0		
			C-2-3	-	-	-		
		25	C-3-1	-	-	-	-	-
			C-3-2	-	-	-		
			C-3-3	-	-	-		
15	Silty clay sand	CS-1-1	506	29.8	94	35	93	
		CS-1-2	471.2	32.6	93			
		CS-1-3	536.2	41.5	92			
		20	CS-2-1	1041.2	39.5	96	37	96
			CS-2-2	1157	35.9	97		
			CS-2-3	917	36.8	98		
		25	CS-3-1	1634.8	36.4	96	53	96
			CS-3-2	1528.2	68.5	96		
			CS-3-3	1326.5	54.8	96		

The general minimum requirement for pervious concrete is a minimum permeability of 15 to 20 in./hr. The results in Table 24 show that all three porosity levels have residual permeabilities of greater than 118 in./hr, well above the general minimum requirement. Maintenance is generally recommended when the permeability coefficient is reduced by 75% of the initial value due to clogging (Mississippi Concrete Industries Association [MCIA] 2002; Othman and Hardiman 2005). With average decreases in permeability in the range of 75%, it would be expected that such PCPC pavements subjected to clogging by sand would require maintenance. However, the high residual permeabilities indicate that the general maintenance requirements may not apply. It should be noted that the sedimentation tests conducted in the lab might be very different from the actual clogging condition in the field because of the great variability of infiltration rate; therefore, this finding may only provide a general idea of how hydraulic performance of pervious concrete would change with time due to sedimentation.

Silty Clay Sand as Sedimentation Materials

When a blended material—silty clay sand—was used as the sedimentation material, significant permeability reductions occurred to all three porosity groups and the permeability reductions were the highest of the three materials. The average residual permeability of all three groups was about 35 to 50 in./hr (Table 24), independent of the initial void ratios and initial permeability coefficients. The average decrease in permeability was from 93 to 96% for the three porosity values. The decrease in permeability was more than when using only sand as the sediment. The change in permeability with number of clogging cycles is shown in Figure 49. It can be seen that the use of a blended material leads to essentially fully clogged conditions in a small number of cycles. From Figure 49, the 15% sample takes only five cycles to become clogged, while the 20% and 25% samples take 13 and 18 cycles, respectively. However, even at these high levels of clogging, the specimens still possess at least 30 in./hr of permeability.

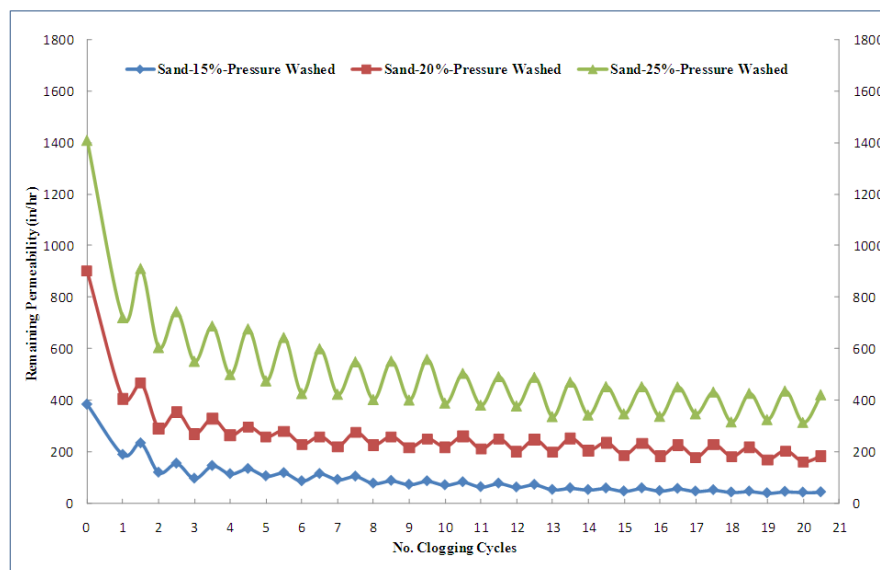

Figure 49. Permeability of specimens subjected to sand sediments and cleaned by pressure washing

During testing with the blended materials, it was observed that fine particles were flushed through the specimens and sand particles were retained on the surface of the specimens. Although fine particles were observed to pass through the specimens, the residual permeability of the blended material specimens was much lower than that of the sand specimens (see Table 24). This is attributed to the wider range of particle size distribution and the cohesion of clay. Silty clay sand contains a wider range of particle size distribution compared to the narrow particle size-ranged sand or clay used in the previous cases. The wider range in particle sizes has two effects: the chances of particles being retained within the specimens are increased, and more interference and clogging of particles occurs within the pores of the specimen. Cohesion of the silty clay particles is responsible for the second effect. The amount of silty clay in the blended materials was around 40% by weight. The silty clay particles may flow through the specimen with sand particles and adhere on the surface of sand particles that were retained. The clogging repetitions would increase the opportunity for silty clay particles to “touch and adhere” to the sand particles, decreasing the permeability.

Case B: Worst (Large) Sedimentation Results

The sediment load for Case B was considered the reasonably worst case with its much higher sediment load than Case A. A total of 1.76 lbs (0.82 kg) of soil was used, applied to simulate a total sedimentation load for 20 years. For the Case B studies, three rehabilitation methods were used: pressure washing, vacuuming, and combined pressure washing and vacuuming. The sedimentation effects from the fine-grained silty clay on pervious concrete were confirmed to be negligible in Case A; therefore, this type of sedimentation effect was not considered in the Case B trials.

For the Case B tests, a clogging cycle consisted of a clogging run in which 0.088 lbs of materials was placed on the specimen surface, water allowed to flow through, and then the specimen cleaned by one of the three rehabilitation methods. The permeability was measured as the dirty water flowed through, until a constant value was achieved. Then the sediments were removed with a selected cleaning method and permeability was measured again. This procedure, involving clogging and then cleaning as one clogging cycle, was conducted a total of 20 times for each specimen to examine the effects of sedimentation and cleaning efficiency.

The Case B test results are shown in Table 25 for pressure washing, Table 26 for vacuuming, and Table 27 for combined pressure washing and vacuuming. The results are discussed below in three sections based on the application of rehabilitation methods.

Sedimentation Followed by Pressure Washing

The results of sedimentation using the three materials followed by pressure washing are shown in Table 25. The results for sand as the sedimentation material show that the average decrease of permeability ranged from 74 to 87%, while the average residual permeability ranged from 54 to 472 in./hr. The average decrease in permeability in percent was similar to the Case A results, indicating that rehabilitation did not appear to affect the percent decrease in permeability. The average residual permeabilities were considerably higher than those found for Case A; however,

the results were very dependent upon porosity. For the lowest porosity, 15%, the average residual porosity for Case B was less than Case A, indicating that cleaning did not have much beneficial effect at this porosity. At the higher porosities, the effect of cleaning was more prevalent.

The results for silty clay as the sedimentation material showed that the average decrease of permeability ranged from 77% to 88%, while the average residual permeability ranged from 114 to 285 in./hr. These results showed slightly more clogging effect using the silty clay than sand, although the results were mixed. The residual permeability at 15% after cleaning for the silty clay materials was considerably higher than for the sand materials. As the average decrease of permeability for the 15% specimens was nearly the same at 86% and 88%, this may simply have been because of the higher initial permeabilities of the specimens used in the silty clay tests. Comparing the results of the silty clay material results from Cases A and B, no cleaning versus cleaning, the average residual permeabilities for cleaning were much higher (114 to 285 in./hr versus 35 to 53 in./hr). This indicates that the cleaning process had a significant effect when silty clay materials were the clogging material. As with sand materials, the lowest porosity specimens were more affected by the clogging than the 20% and 25% specimens.

The change in permeability with clogging cycles using sand is shown in Figure 49 for the three porosities and is typical of the results found for all the cleaning methods. It can be seen that the cleaning has the most effect per cycle on the highest porosity concrete and the least effect on the lowest porosity concrete. It can also be seen that the most significant drop in permeability occurs within the first few cycles, again with the least effect on the highest porosity concretes. The magnitude of recovery for each cycle also decreases with continuing cycles for all porosities. At the lowest porosity, there is very little recovery in permeability with cleaning after about 10 cycles. At 20% porosity, the recovery in permeability is rather constant after about five cycles. The recovery in permeability with cleaning is greatest for the 25% specimens, although the recovery decreases slightly with increasing cycles.

Sedimentation Followed by Vacuuming

The results of sedimentation using the three materials followed by vacuuming are shown in Table 26. The results for sand as the sedimentation material show that the average decrease of permeability ranges from 67% to 85%, while the average residual permeability ranges from 87 to 497 in./hr. The results are quite similar to the results from pressure washing and appear to indicate that there is not much difference in choice of rehabilitation method. As with pressure washing, the residual permeability for the lowest porosity after vacuuming was considerably lower than the residual permeability for the other two porosities. The results for silty clay as the sedimentation material show that the average decrease of permeability ranged from 74% to 89%, while the average residual permeability ranged from 48 to 216 in./hr. The average decrease in permeability as a percentage was similar to the sand results; however, the average residual permeabilities were considerably lower for the silty clay materials compared to the sand material results. This would appear to indicate that the silty clay materials are less conducive to cleaning by vacuuming than the sand materials. In comparing the silty clay results of vacuuming versus pressure washing, it can be seen that the residual permeabilities after pressure washing were

higher at each porosity. This may be because the vacuuming took place after drying, which allowed the fine particles to better adhere to the concrete while pressure washing with water allowed better cleaning of the fine particles.

Sedimentation Followed by Combined Pressure Washing and Vacuuming

The results of sedimentation using the three materials followed by combined pressure washing and vacuuming are shown in Table 27. The results using the combined pressure washing and vacuuming follow similar trends to the use of each method separately; the lowest porosity specimens show the lowest average residual permeability. Overall, the effect of using both rehabilitation methods rather than just one is a slight improvement in the residual permeability compared to the use of a single rehabilitation method.

Table 25. Changes in coefficient of permeability of the Case B sediments test (by pressure washing)

Design Porosity (%)	Sedimentation Materials	Specimen	Initial Permeability Coeff. (in./hr)	Residual Permeability Coeff. (in./hr)	Decrease in Permeability after Sedimentation (%)	Average Residual Permeability (in/hr.)	Average Decrease of Permeability (%)
15	Sand	S-P-1-1	404.8	26.4	93	54	87
		S-P-1-2	361.8	60.3	83		
		S-P-1-3	448.74	74.3	83		
20	Sand	S-P-2-1	835.1	145.5	83	182	80
		S-P-2-2	833.9	228.8	73		
		S-P-2-3	1031.9	171.5	83		
25	Sand	S-P-3-1	1560.4	513.4	83	472	74
		S-P-3-2	1437.4	422.9	67		
		S-P-3-3	1223.8	480.9	71		
15	Silty clay sand	CS-P-1-1	565.8	74.6	85	114	88
		CS-P-1-2	684.3	49.3	89		
		CS-P-1-3	548.7	217.6	91		
20	Silty clay sand	CS-P-2-1	936.7	237.5	77	238	78
		CS-P-2-2	1048.9	238.6	77		
		CS-P-2-3	1137.2	239.5	79		
25	Silty clay sand	CS-P-1-1	1183.1	255.7	78	285	77
		CS-P-2-2	1048.4	302.6	71		
		CS-P-3-3	1597.6	297.6	81		

Table 26. Changes in coefficient of permeability of the Case B sediments test (by vacuuming)

Design Porosity (%)	Sedimentation Materials	Specimen	Initial Permeability Coeff. (in./hr)	Residual Permeability Coeff. (in./hr)	Decrease Permeability after Sedimentation (%)	Average Residual Permeability (in./hr.)	Average Decrease of Permeability (%)
15	Sand	S-V-1-1	569.9	69.3	88	87	85
		S-V-1-2	618.3	84.6	86		
		S-V-1-3	591.3	108.5	82		
20	Sand	S-V-2-1	714.6	236.9	67	232	69
		S-V-2-2	805.4	265.1	67		
		S-V-2-3	697.6	194.3	72		
25	Sand	S-V-3-1	1661.3	464.7	72	497	67
		S-V-3-2	1539.4	494.5	68		
		S-V-3-3	1318.7	531.9	60		
15	Silty clay sand	CS-V-1-1	494	39.1	92	48	89
		CS-V-1-2	513.6	43.6	92		
		CS-V-1-3	358.3	61.3	83		
20	Silty clay sand	CS-V-2-1	724.8	245.6	66	174	74
		CS-V-2-2	691.2	138.2	80		
		CS-V-2-3	548.6	136.9	75		
25	Silty clay sand	CS-V-3-1	1501.6	196.4	87	216	86
		CS-V-3-2	1489.2	239.4	84		
		CS-V-3-3	1748.6	213.5	88		

Table 27. Changes in coefficient of permeability of the Case B sediments test (by pressure washing and vacuuming)

Design Porosity (%)	Sedimentation Materials	Specimen	Initial Permeability Coeff. (in./hr)	Average Residual Permeability Coeff. (in./hr)	Decrease Permeability after Sedimentation (in./hr)	Average Residual Permeability (in./hr.)	Average Decrease of Permeability (%)
15	Sand	S-VP-1-1	459.4	98.6	79	122	76
		S-VP-1-2	509.4	135.6	73		
		S-VP-1-3	538.5	130.6	76		
20		S-VP-2-1	1130.2	347.6	69	372	68
		S-VP-2-2	1256.7	428.6	66		
		S-VP-2-3	1097.5	338.6	69		
25		S-VP-3-1	1683.9	508.9	70	488	70
		S-VP-3-2	1544.6	438.5	72		
		S-VP-3-3	1627.6	517.5	68		
15	Silty clay sand	CS-VP-1-1	494.4	58.6	88	80	86
		CS-VP-1-2	598.6	94.5	84		
		CS-VP-1-3	574.6	87.6	85		
20		CS-VP-2-1	1025.6	284.6	82	253	81
		CS-VP-2-2	1128.6	247.5	78		
		CS-VP-2-3	1289.6	227.5	82		
25		CS-VP-3-1	1428.5	328.4	77	357	75
		CS-VP-3-2	1384.5	374.9	73		
		CS-VP-3-3	1458.6	369.5	75		

Discussion

The results presented above are interpreted from the three perspectives of sedimentation material characteristics, porosity of the PCPC, and rehabilitation methods. In the clogging tests conducted, the water flowed through the specimens in one direction. The water with sediments flowed through a confined space, which may have tended to push the sediments deeper into the specimens. The initial high head of the water (18 in.) may also have contributed to this effect. Also, because of the great variability of infiltration rate and density of in-place pervious concrete pavement, the testing results in this study based on a simulated clogging test may not truly indicate the “real” case; but it is more important to provide a guide for considering and preventing the clogging effect of pervious concrete from occurring in terms of three perspectives as mentioned above, which would be helpful in establishing a quantitative and accurate study on the clogging effect of pervious concrete pavement.

Effect of Sedimentation Materials

The sedimentation tests showed that sand materials will most likely be trapped on the surface or near the top zone within the specimen, the fine-grained silty clay materials will wash through the specimens, and the blended silty clay sand materials will be deposited within the concrete or travel through the concrete and then be retained in the space between the concrete and filter fabric or underlying soil. Based on the permeability results, the silty clay materials have negligible effects on permeability, while the sand and blended materials cause significant decreases in permeability. However, the lowest residual permeabilities measured were still above 30 in./hr (for blended materials with no cleaning), values that should provide sufficient water flow under even the heaviest rainstorms. In general, the residual permeabilities after cleaning for the sand and blended materials were well above 100 in./hr except for the 15% porosity samples.

Effect of Porosity of the PCPC

The test results showed that the higher porosities achieved the higher residual permeability coefficients of the clogged specimens subjected to the same sedimentation loads without rehabilitation methods applied (Case A long-term low sediment loading). For the Case B (long-term high sediment loading) results, the specimens with greater porosities always achieved the higher residual permeability and better permeability recoveries after cleaning. This is true for all three of the rehabilitation methods conducted. Based on the test results for Cases A and B, a minimum design porosity of 20% is recommended for pervious concrete pavement in terms of clogging consideration. For 15% as a design porosity, there is a possibility of poor hydraulic performance. For 25% as a design porosity, the hydraulic performance may be overdesigned and other considerations such as strength may be an overriding factor.

Effect of Rehabilitation Methods

All three rehabilitation methods provided improved residual permeability compared to not cleaning. The pressure washing and vacuum methods produced similar residual permeabilities,

while the combination of the two provided a slight improvement over the individual methods. Graphs of permeability versus cycles of clogging (sedimentation plus cleaning) showed that the effects of clogging are greatest in the first one or two cycles and that limited changes in residual permeability take place after five to ten cycles. The rehabilitation methods were always more effective on the higher-porosity specimens. The rehabilitation methods had negligible effect on the permeabilities of specimens with 15% porosity.

Comparisons of the effects of the three rehabilitation methods for the three porosities are shown in Figure 50 to Figure 55. These figures show that pressure washing and vacuuming have approximately the same remaining percentage, and the combined pressure washing and vacuuming has the highest remaining permeability percentage. The sand sedimentation results (Figure 50 to Figure 52) show that the residual permeability of clogged specimens cleaned by the combined method keeps a fairly constant value at 30% of initial permeability with increasing clogging cycles. By contrast, applying only pressure washing or vacuuming kept approximately 20% of the initial permeability for specimens containing 20% and 25% of void ratios and only 10% for those containing 15% of void ratios. With silty clay sand sedimentation (Figure 52 to Figure 55) the combined method kept a fairly constant value at 20% of initial permeability with increasing clogging cycles. By contrast, applying pressure washing or vacuuming only kept 10–20% of initial permeability for specimens containing 20% and 25% of void ratios and less than 10% for those containing 15% of void ratios.

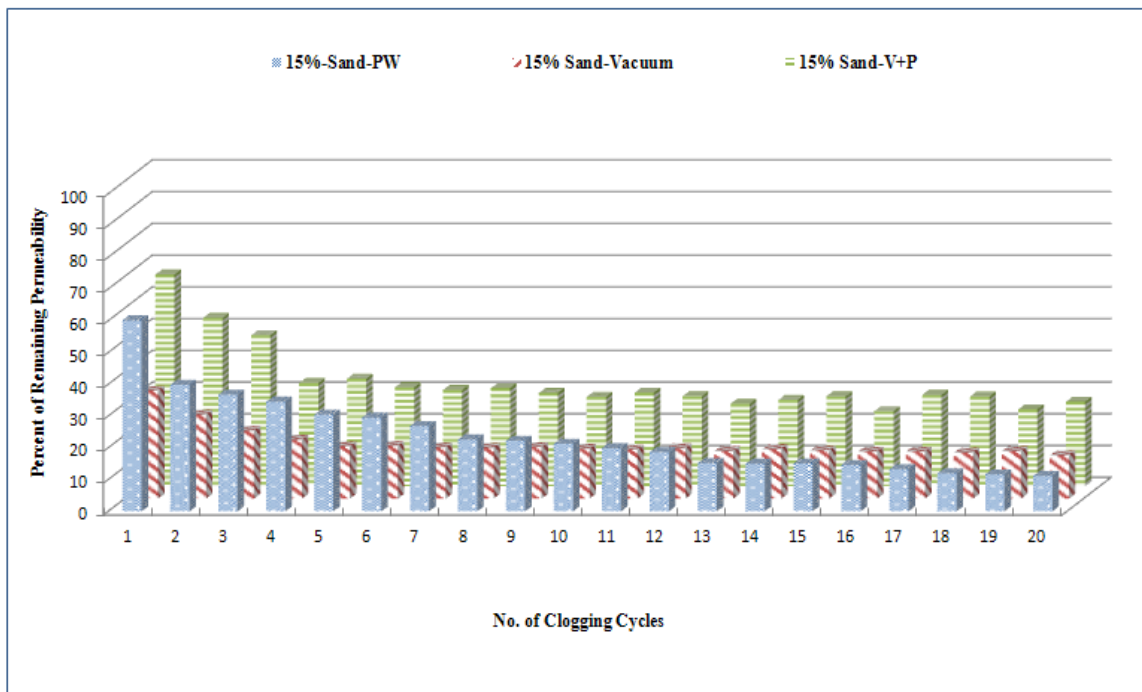

Figure 50. Sand specimens, 15 percent porosity, cleaned by three rehabilitation methods

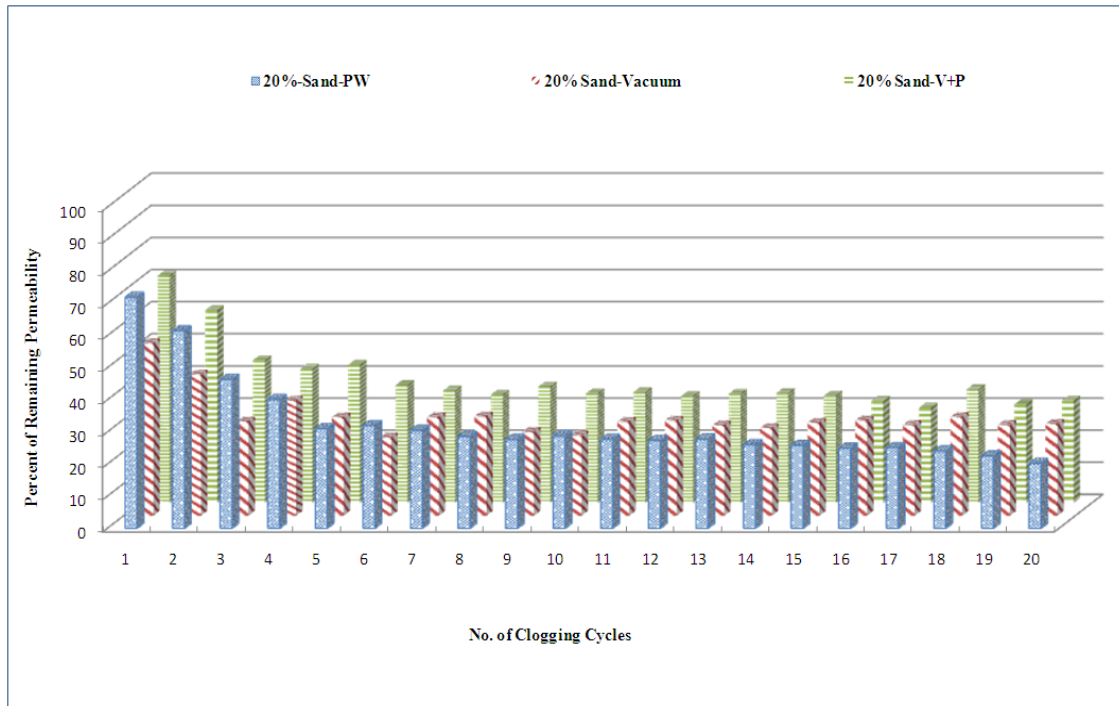

Figure 51. Sand specimens, 20 percent porosity, cleaned by three rehabilitation methods

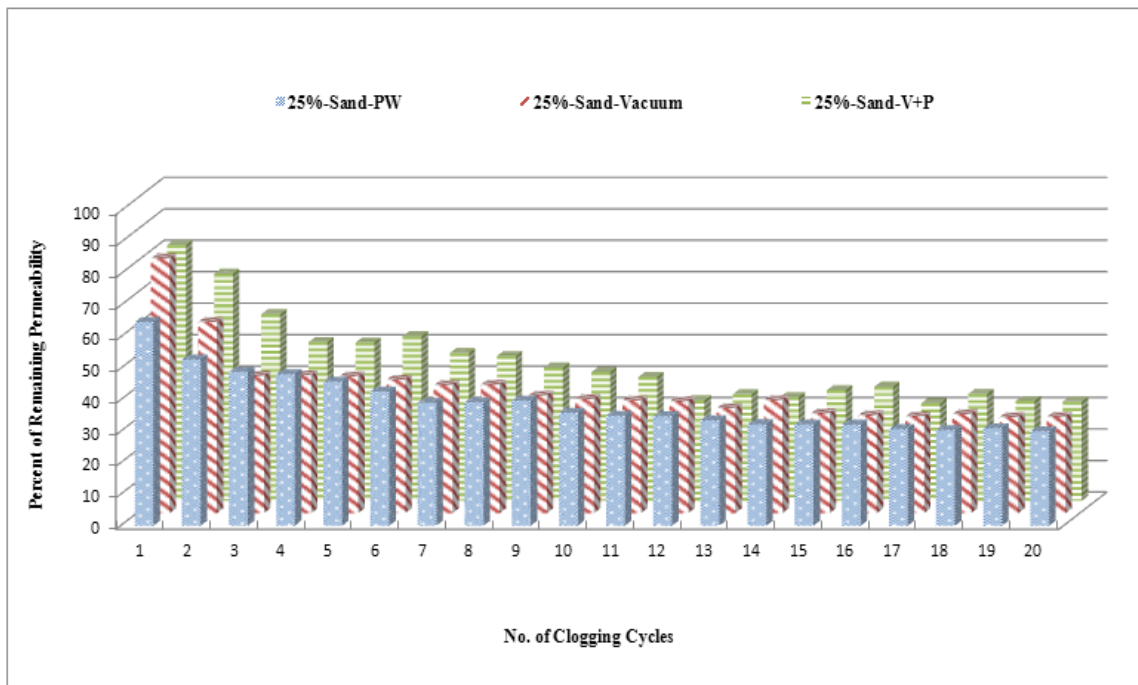

Figure 52. Sand specimens, 25 percent porosity, cleaned by three rehabilitation methods

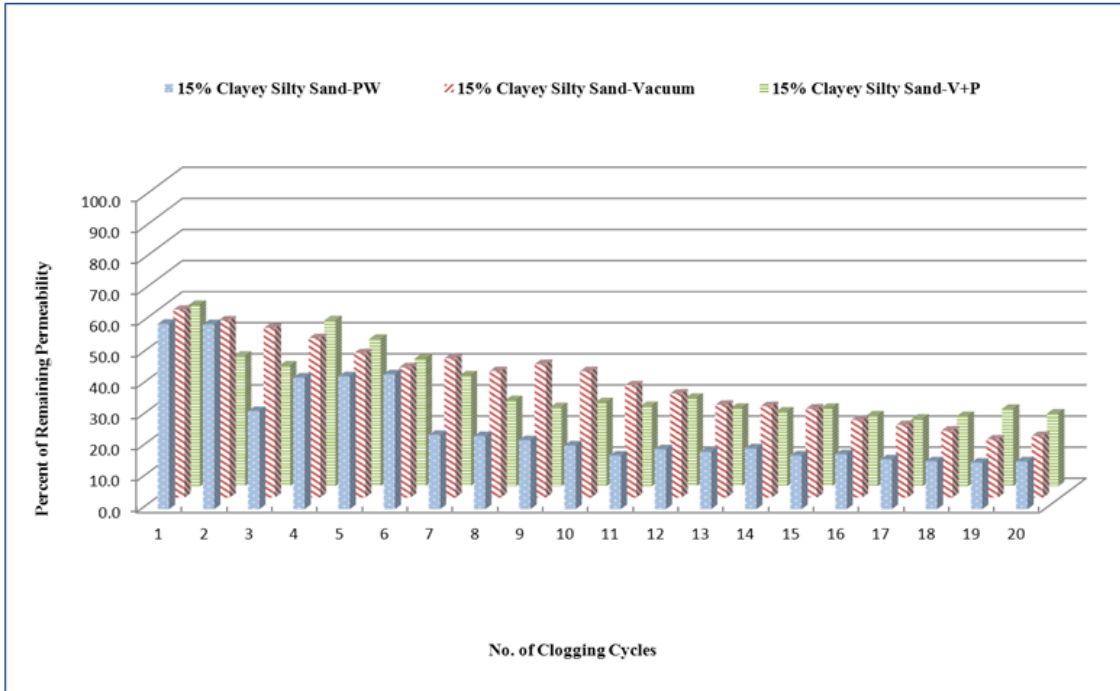

Figure 53. Silty clay sand specimens, 15 percent porosity, cleaned by three rehabilitation methods

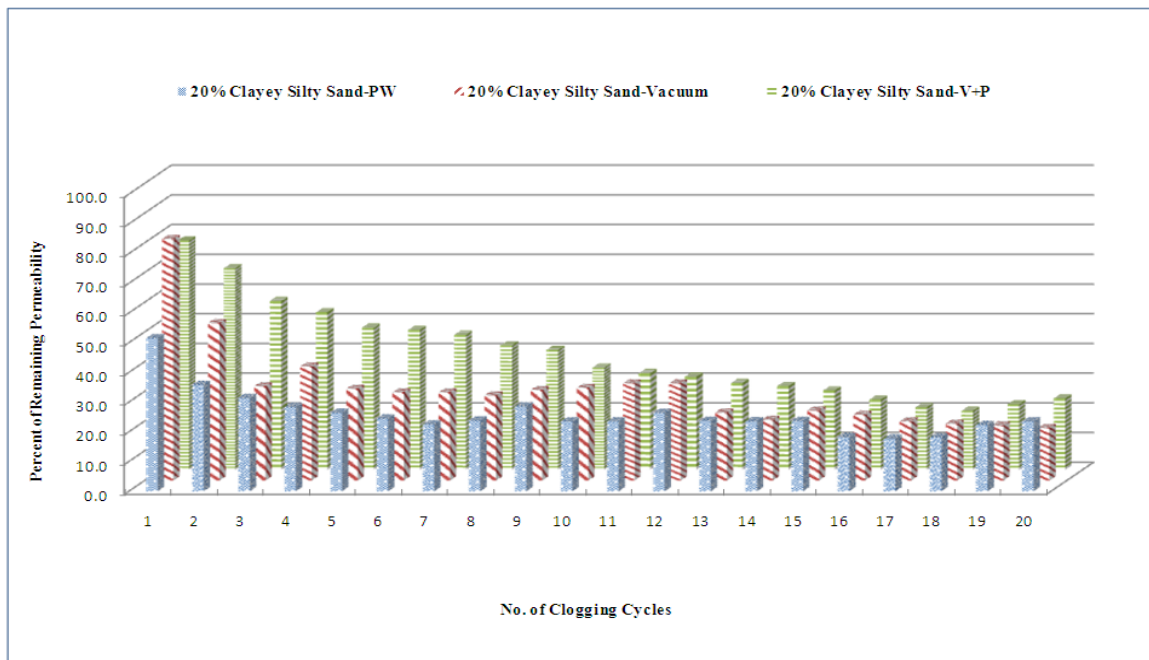

Figure 54. Silty clay sand specimens, 20 percent porosity, cleaned by three rehabilitation methods

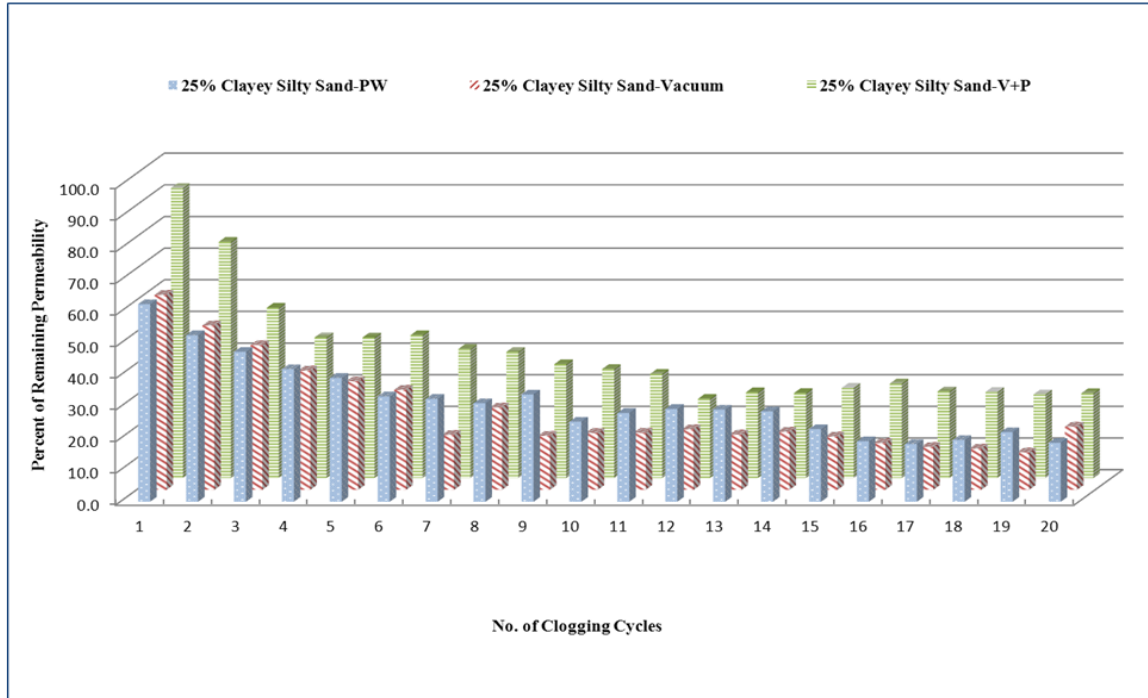

Figure 55. Silty clay sand specimens, 25 percent porosity, cleaned by three rehabilitation methods

Design Considerations and Maintenance Strategy for PCPC Pavement Subjected to Clogging Issues

Based on the testing results, design recommendations developed in this study are summarized as below, based on different clogging conditions. This may provide a reference for in-situ pervious concrete construction. The composition, soil properties, and gradation of subgrade materials should be determined and taken into the consideration of pavement design and maintenance.

Sand

The high residual permeability of samples clogged with cohesionless sand indicates little required maintenance when the pavement has sufficient initial permeability. The experimentally determined residual permeability can still reach more than 30 in./hr for 15% of initial porosity, 200 in./hr for 20% of initial porosity, and 570 in./hr for 25% of initial porosity. These values were obtained without applying maintenance. Under this case, a high initial porosity of pervious pavements of around 25% is preferred to achieve the higher residual permeability and cleaning efficiency, if it is necessary. If sand is the primary clogging material, dry cleaning is recommended.

Cohesive Materials

When the localized subgrade soil and potential clogging material are mostly cohesive, the clogging effect on hydraulic performance of the PCPC layer is negligible and independent with the design initial porosity. For a pure cohesive, fine-grained material, a majority of the sedimentation materials passed through the pervious concrete surface layer. An appropriate initial porosity may be selected to achieve the hydraulic performance based on local precipitation amount, stormwater runoff, site characteristics, and surrounding areas. However, the accumulation of a clay layer within the space between the concrete layer and filter fabric may reduce the system permeability. Under this sedimentation case, based on the properties of cohesive material, it is preferable to conduct the maintenance operation in the wet condition, and pre-wetting is recommended prior to conducting maintenance. Pressure washing followed by vacuuming is preferred. Also, the opening size of the filter fabric used in PCPC construction should be at least No. 200 sieve size (75 μm) to allow the passing of fine particles.

Blended Materials

When the localized subgrade soil and potential clogging material are mostly blended material, the clogging effect on hydraulic performance of the PCPC layer is the most significant. A combination of particle sizes and surface characteristics is the most likely case for a majority of the country. Greater permeability reductions were obtained in this case. Independent with the initial porosity, the residual permeability for all specimens is approximately 30 in./hr without the application of maintenance. With the maintenance, in this case, residual permeabilities are dependent on the initial porosities of the PCPC specimens. Overall, specimens containing 25% of initial porosity and cleaned by annual pressure washing followed by vacuuming show the highest residual permeability at around 430 in./hr. Therefore, under this sedimentation case, the greater initial porosity and the combined pressure washing and vacuuming are preferred. Because of the large amount of cohesive materials, a pre-wetting activity is recommended before conducting the maintenance.

CHAPTER 9. DEVELOPMENT OF AN OVERLAY DESIGN METHODOLOGY

Introduction

For a bonded overlay to be successful, the mixture must be workable, durable, strong enough, and sufficiently bonded to the underlying substrate. Chapters 3 through 7 addressed mixture proportioning and durability to allow selection of a desirable PCPC mixture. However, the mixture proportions alone do not guarantee a successful project and once mixture proportioning and durability testing were complete, the bond characteristics were evaluated. This chapter describes testing performed before installation to determine necessary bond properties, and Chapters 10 and 11 describe information determined after installation regarding bonding and cracking related to future designs.

This project represents a first attempt at a wet-on-dry pervious concrete overlay. Wet-on-wet placement, where the pervious concrete is bonded to fresh traditional concrete, has been performed in Belgium, the Netherlands, and Australia previously (Bax et al. 2007; Beeldens 2001; Vorobieff and Donald 2008). The motivation for employing pervious concrete as a road surface includes noise reduction in urban areas and reduced splash, spray, and hydroplaning potential for safer pavement (Beeldens 2001; Olek et al. 2003; Vorobieff and Habair 2005). Experience from Belgium has shown that at least 40 mm (1.5 in.) of pervious concrete is required for noise reduction and a layer of at least 70 mm (2.75 in.) is recommended for proper lateral drainage (BRITE 1994). The Australian test sections utilized a 50 mm (2 in.) pervious concrete surface layer. These sections were placed using dual slip-form pavers where the first paver placed the traditional concrete and, when sufficient strength had been gained, a second paver placed the pervious concrete layer. The selected pervious concrete mixtures were generally stiff without extra free paste, and it was noted that when the underlying concrete had set up too much, no bonding occurred.

The unique pervious concrete overlay experience in the Netherlands used a precast arrangement where the slabs were cast surface down. Two 20 mm (0.75 in.) pervious concrete layers were cast first, followed by a prestressed traditional concrete layer. The surface layer contained 4.75 mm (0.25 in.) aggregate, followed by a much larger 37.5 mm (1.5 in.) pervious concrete mixture. Again, placements were performed wet-on-wet (Bax et al. 2007).

Gaining sufficient bond strength was a significant challenge for the wet-on-wet placements. From the onset of this project, the overlay mixture was designed for wet-on-dry placement. Paste workability is important for good bonding of traditional concrete overlays, and the new method developed in Chapter 4 allowed selection of a mixture with good properties and workable paste for good bond characteristics.

Laboratory Overlay Bond Strength Testing

Overlay bond strength was tested according to Iowa DOT test method 406C. The test standard calls for applying a constant load at 2.8 to 3.4 MPa/minute (400 to 500 psi/minute) to a 100 mm

(4 in.) diameter specimen (Iowa DOT 2000). Traditional concrete samples were placed at approximately a 100 mm (4 in.) height. After curing for 28 days, an additional 100 mm (4 in.) of pervious concrete was placed on the hardened concrete. The surface of the PCPC was leveled using a flat plate without applying any pressure. The reported bond strength is the maximum achieved. Overlay bond strength testing is shown in Figure 56.

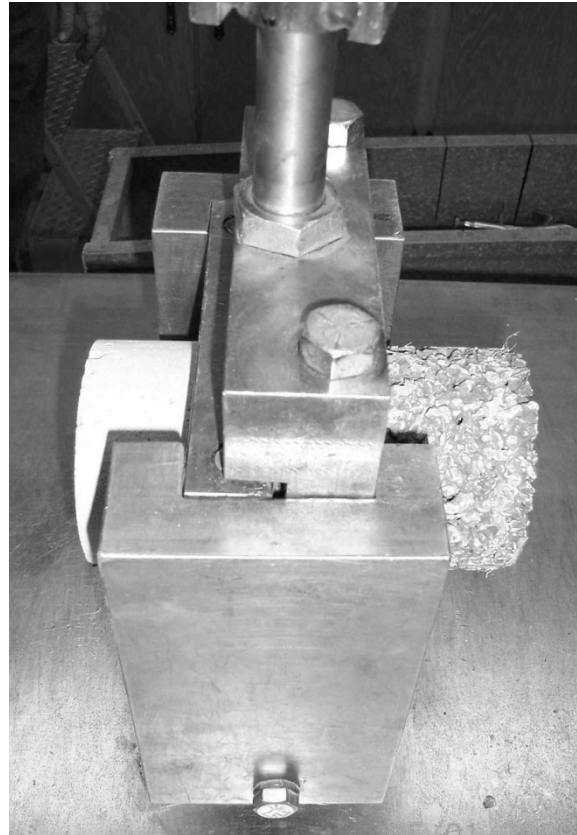

Figure 56. Overlay bond strength test setup

Fresh PCPC samples were placed over hardened concrete without any vibration or compaction to represent the lowest anticipated bond strength. Four different surface preparation techniques were used on both of the selected mixtures: (1) clean and dry concrete surface, (2) latex polymer additive applied as a tack coat and topped with fresh concrete while tacky, (3) standard mortar surface grout, and (4) polymer mortar surface grout (Table 28). Five samples of the clean and dry combination were placed, and all other combinations had four samples. Generally, bond strength values were highly variable, indicating more samples are required for any statistical determination. The grouted samples had the highest bond strengths, with the nonlatex polymer concrete having the higher strength. The latex polymer had better bond strength on the clean and dry concrete than the mixture containing the VMA. The polymer tack coat did the opposite as expected and prevented bonding of either PCPC mixture.

Because additional vibration from the placing equipment was anticipated to cause some paste draining, additional bond strength was expected for the clean preparation method in the field.

Since current overlay bond construction utilizes a clean, moistened underlying pavement, that was selected for field construction.

Table 28. Bond strength testing results

Mixture	Bond Type	Strength	Bond Type	Strength	Bond Type	Strength	Bond Type	Strength
Non-Latex Polymer	Clean and Dry	Mpa (psi)	Latex Polymer Tack Coat	Mpa (psi)	Grout	Mpa (psi)	Latex Polymer Grout	Mpa (psi)
		0.04 (6)		0.04 (6)		1.21 (175)		0.86 (125)
		0.13 (19)		0.05 (7)		2.00 (290)		1.58 (327)
		0.14 (20)		0.06 (9)		2.02 (293)		2.35 (341)
		0.25 (37)				2.65 (385)		
		0.32 (47)						
	Avg.	0.27 (26)	Avg.	0.05 (7)	Avg.	2.22 (323)	Avg.	1.83 (265)
	Std. Dev.	0.11 (16)	Std. Dev.	0.01 (2)	Std. Dev.	0.37 (54)	Std. Dev.	0.69 (100)
	COV (%)	62	COV (%)	22	COV (%)	17	COV (%)	39
Latex Polymer	Clean and Dry	Mpa (psi)	Latex Polymer Tack Coat	Mpa (psi)	Grout	Mpa (psi)	Latex Polymer Grout	Mpa (psi)
		0.15 (22)		0.05 (7)		0.55 (80)		1.20 (174)
		0.34 (49)				1.24 (180)		1.23 (178)
		0.62 (90)				1.43 (207)		1.50 (217)
		1.22 (177)				2.24 (325)		2.76 (401)
		1.48 (215)						
	Avg.	0.76 (111)	Avg.		Avg.	1.36 (198)	Avg.	1.67 (243)
	Std. Dev.	0.57 (83)	Std. Dev.		Std. Dev.	0.70 (101)	Std. Dev.	0.74 (108)
	COV (%)	75	COV (%)		COV (%)	51	COV (%)	44

Field Investigation Related to Overlay Design

Bonding

Core samples were removed for unit weight and permeability testing prior to the first field visit in 2009. Image analysis was used to determine the percent of the total core area bonded to the underlying pavement. Figure 57 shows the refined image for Core 1 yielding 24% bonded area. As shown in Table 30, the panel six south lane core had 26% voids, which suggests complete bonding of the core sample. Data for the remaining cores are shown in Table 29 and are consistent with Core 1.

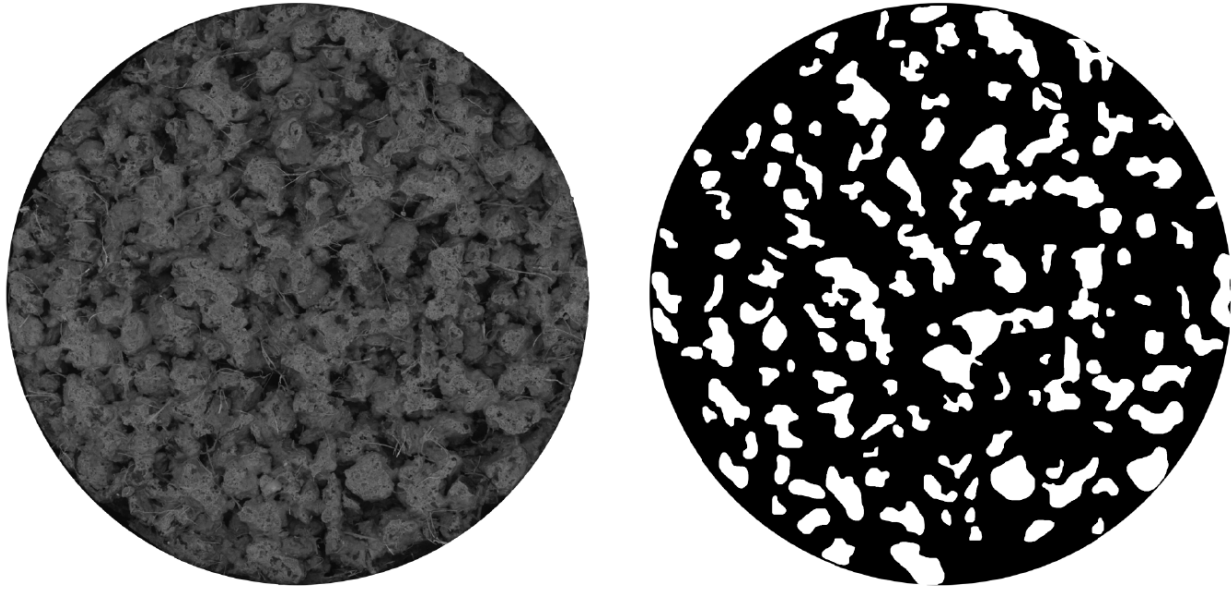

Figure 57. Determination of bonding from core samples

Table 29. Bonding of core samples

Core	Voids (%)	Percent Bonded (%)
Panel 6 South Lane (Env)	26	24
Panel 6 North Lane (Drive)	29	23
Panel 16 South Lane (Env)	19	22
Panel 16 North Lane (Drive)	37	38

Cracking

Previous investigation by Bax et al. (2007) suggested that 145 psi (21 kPa) was the required bond strength for good overlay performance. Conservative, uncompacted, and unvibrated laboratory testing showed highly variable bond strength, but sufficient bonding did occur for the selected mixture and surface preparation method. The overlay panel size was matched with the existing panel size of 20 ft. x 12 ft. (6 m x 3.7 m) to observe any mid-panel cracking due to over stressing.

Design Recommendations for Future Pervious Concrete Overlays

From the literature review, the required overlay bond strength was low. Overlay bond testing of both mixtures in the lab was performed on several surface preparation conditions. Generally, the results of the bond testing were highly variable, with both grout combinations having the highest strength. The clean and dry surface preparation had sufficient bonding for the polymer mix but poor bonding for the mixture containing VMA. The polymer admixture was not able to function

as a tack coat. Core samples removed from the actual placement had good bond characteristics, while the limited number of service cracks indicate larger panel sizes may be appropriate. Long-term monitoring is required to more fully develop a robust design procedure.

CHAPTER 10. PERVIOUS OVERLAY CONSTRUCTION AT MNROAD

Introduction to Overlay Construction

Portland cement pervious concrete contains the same material components as conventional concrete of cementitious binder, aggregate, water, and chemical admixtures, but through specific mixture proportioning maintains around 20% porosity for water percolation. Common usage of PCPC in the United States is as a method to convey stormwater into an underlying aggregate storage layer to allow infiltration and manage stormwater runoff requirements (U.S.EPA 2004; Tennis et al. 2004). However, PCPC has also been used in limited applications for noise reduction and increased skid resistance on high-volume roadways in Europe and Japan (Beeldens 2001; Schaefer et al. 2006), where it has shown great potential to reduce roadway noise, improve splash and spray, and improve friction as a surface-wearing course. A pervious concrete mix design for a surface-wearing course must meet the criteria of adequate strength and durability under site-specific loading and environmental conditions. To date, two key issues that have impeded the use of pervious concrete in the United States are that strengths of pervious concrete have been lower than necessary for required applications and the freeze-thaw durability of pervious concrete has been suspect.

The strength and freeze-thaw durability of pervious concrete mix designs have been addressed in Chapters 5, 6, and 7, showing that a strong, durable pervious concrete mix design that will withstand hard, wet-freeze environments is possible. The strength and durability is achieved through the use of a small amount of fine aggregate (i.e., concrete sand) and/or latex admixture to enhance the particle-to-particle bond in the mix.

The selected mixture was designed for wearing-course applications and to possess surface characteristics that reduce noise and enhance skid resistance, while providing adequate removal of water from the pavement surface and structure. Additionally, constructability issues for wearing-course sections were addressed to ensure that competitive and economical placement of the pervious concrete could be performed in the field.

To maximize the potential benefits of pervious concrete as an overlay material for noise reduction and skid resistance, the mixture needed to possess the following properties:

- Adequate strength for long-term durability
- Highly durable aggregate for resistance to polishing and freeze-thaw issues
- Sufficient porosity (around 20% to 25%) to maximize noise reduction and minimize maintenance
- High workability for ease of placement and uniform porosity across the pavement thickness
- Ability to maintain voids when compaction is applied by the paver for uniform surface porosity

MnROAD Facility

The MnROAD facility was constructed by the Minnesota Department of Transportation (MnDOT) between 1990 and 1993 as a cold weather testing facility. The facility is located 40 miles northwest of Minneapolis/St. Paul along Interstate 94 and is an extensive pavement research facility consisting of two separate roadway segments—one a test section of I-94 carrying interstate traffic and one a low-volume roadway that simulates conditions on rural roads. Each of the segments is divided up into test cells approximately 500 ft long that have varying surface materials, aggregate base, subgrade, roadbed structure, and drainage methods. The original test facility contained some 40 distinct test cells. The mainline segment is a 3.5 mile (5.6 kilometer [km]) section parallel to I-94 with the capability to divert westbound traffic from I-94 to the mainline section. The Low-Volume Road (LVR) is a closed 2.5 mile (4 km) loop. Pavement on the LVR contains two lanes, one tested with an 80 kip (36,300 kg) controlled 18-wheel, five-axle tractor/trailer (inside lane), and the second environmental lane with no traffic load (outside lane). The low-volume loop contains 24 approximately 500 ft (150 m) long test cells containing different pavement types, thicknesses, and subbase/subgrade structures. A detailed map of the LVR can be found on the MnROAD website at <http://www.dot.state.mn.us/mnroad/testsections/pdfs/lvr-profile-p.pdf>.

Testing on MnROAD segments continued between 1993 and 2007, when a second phase was initiated. Reconstruction of MnROAD began in 2007 and was completed in 2009 with new cells consisting of both new construction and rehabilitation techniques representing both national and regional interests. Phase II developed under the auspices of the Transportation Engineering and Road Research Alliance, a research governance structure formed in 2004 to foster a comprehensive road research program, and brings together government, industry, and academia in a dynamic partnership to advance innovations in road engineering and construction. Its mission is to develop, sustain, and communicate a comprehensive program of research on pavement, materials, and related transportation engineering challenges, including issues related to cold climates. Key aspects of the MnROAD facilities are the large investment in instrumentation of test cells and a dedicated support staff. Historical sampling, testing, and construction information is available in the MnROAD database online. Additional information on MnROAD can also be found on its web site at <http://www.dot.state.mn.us/mnroad/index.html>.

Pervious Concrete Overlay Project

The pervious concrete overlay was constructed on Cell 39 of the LVR, over concrete that was originally constructed during July 1993. The PCPC overlay is nominally 4 in. (100 mm) thick with formed joints approximately over the original skewed joints. Cell 39 of the LVR is approximately 500 ft in length and consists of concrete pavement nominally 6.5 in. (165 mm) thick with transverse tining, skewed joints, and 20 ft x 12 ft (6 m x 3.7 m) panels. Load transfer is achieved with 1 in. (25 mm) dowels. The subbase is 5 in. (125 mm) Class 5 well-graded aggregate base and subgrade is clay. A cross-section and plan view is shown in Figure 58 and gives typical dimensions of the cell. The north lane is the inside lane and is the lane over which the tractor/trailer travels. The south lane is an environmental lane and is not loaded with vehicular traffic. The original concrete pavement and the pervious concrete overlay were

instrumented with two types of strain gauges, as shown in Figure 58. The overlay panel size was selected to match the existing panels, which is not recommended for typical concrete overlays. The large panel size was selected to observe any overlay mid-panel cracking because of thermal or loading stresses for bond strength verification. With the large panel size and relatively low bond strength compared to typical concrete overlays, mid-panel cracking was expected.

Construction

Preparation

The pervious concrete overlay was placed on an existing concrete pavement section in Cell 39. Preparation for placement of the overlay was relatively minor, necessitating only cleaning of the existing concrete surface. On September 29, 2008, the surface of Cell 39 was sandblasted and swept clean. Forms were fixed to the existing pavement. Notches were milled into the concrete on both ends of the cell, and bituminous tapers were placed as transitions to the overlay.

The cell was originally designed and built with a Class 5 aggregate shoulder. Shortly after the pervious concrete construction, it was noted that water draining to the pavement edge from the pervious overlay simply sat on the aggregate shoulder because the aggregate was, for all practical purposes, impervious. The MnROAD operations staff corrected the problem by installing French drains along both shoulders. The drains were approximately six inches wide and four inches deep along the entire length of both sides of the cell. The drains were backfilled with an open-graded concrete aggregate. Transverse outlet drains were placed approximately every 100 ft along the shoulders.

Concrete Placement

Previous experience with field placement and quality control of pervious concrete installations for parking lots, recreational facilities, and stormwater improvements has shown that construction details are important in the resultant product (Kevern et al. 2006; Kevern et al. 2008e; Schaefer et al. 2008). The original mix design development work for this project envisioned machine placement of the overlay. For placement of the overlay using forms, a construction process was recommended, consisting of the following steps:

- Ready-mix truck arrives on site and workability is checked using the inverse slump flow method
- Concrete is direct discharged onto surface; fresh concrete is raked roughly 0.5 in. above the forms
- An initially 5- to 10-ft section is finished with the roller screed
- The roller screed is returned to the starting position of the previous pass
- A thin layer of concrete is raked onto the previous finished surface
- The same 5- to 10-ft section is refinished with the roller screed, resulting in a double pass to provide a uniform surface
- Immediately following the second roller pass, the finished surface is sprayed with the selected curing compound
- Jointing, edging, or other finishing operations are performed; the overlay is to be jointed with ONE pass of the pizza cutter; with two or more passes, the cutter does not track exactly in the same position and joint raveling potential increases
- Cover with plastic, ensuring that a maximum of 10 ft of concrete is exposed behind the screed
- Secure the edges of the plastic with sand bags
- Cure covered for at least seven days; remove the plastic

The environmental lane (outside lane, south side) was constructed first on Wednesday, October 1. Delivered concrete temperature was maintained at 60°F (15°C). Placement air temperature ranged from 40°F to 54°F (4°C to 12°C) with 3 to 5 mph (5 to 8 kph) winds from the northwest, wind gusting to 11 mph (18 kph). The traffic lane (inside lane, north side) was constructed on October 17. Placement air temperature ranged from 40°F to 52°F (4°C to 11°C) with 1 to 2 mph (2 to 3 kph) winds from the northwest, wind gusting to 5 mph (8 kph). The batch facility was approximately 30 minutes from the site, and the concrete was delivered to the site in eight cubic yard (cu yd) batches. The delivered concrete temperature was maintained at 60°F (15°C). Approximately 150 cu yds of concrete were used in each lane. In general, the above-enumerated process was followed during placement of both lanes of Cell 39. An inverse slump test was not conducted, and thus, workability could not be assessed. The existing concrete surface was pre-wetted with water prior to placement of the pervious concrete material. In appearance, the aggregates were well coated and fibers appeared to be well dispersed throughout the mix. The contractor used a three-tube powered roller-screed and finished the surface in five to 10 ft sections with an initial pass, backed up two to three feet, added fresh concrete to the surface as needed, and finishing continued with the roller-screed. Placement of concrete and the initial pass of the roller-screed are shown in Figure 59. Following the second pass, the finished surface was

sprayed with a mono-molecular curing compound and the joints were formed and aligned to the existing pavement joints, which were skewed. In creating the joints, multiple passes (two to four) were made using the jointing device. The surface was then covered with plastic sheets secured with rebar, as shown in Figure 60. The plastic was removed after seven days. The finished surface texture is shown in Figure 61.

Test specimens were placed during both of days of construction. Compressive and flexural strength values were good with compressive strength greater than 4,000 psi (27.6 MPa) and flexural strength greater than 900 psi (6.2 MPa) at 28 days. However, the method of compaction was not provided by the testing agency, along with unit weight or void data. Without corresponding unit weight data, it is inappropriate to report official values for the placement. Permeability and voids were measured on cores removed from the pavement as reported in Table 29. Using actual voids along with the compaction density relationship shown in Figure 29, predicted compressive strength is near 3,000 psi (20 MPa).

Further construction details can be found in the MnDOT construction report (Izevbekhai 2008).



Figure 59. Placement of pervious concrete overlay using roller-screed



Figure 60. Completed surface of pervious overlay and covering with two layers of plastic



Figure 61. Representative surface

CHAPTER 11. FIELD CONDITION INVESTIGATION RESULTS

Introduction to Field Investigation

Three visits were made to the site during the project to conduct condition surveys, perform field infiltration testing, obtain samples for laboratory permeability testing, and observe the overall performance of the pervious concrete overlay.

The first visit was on May 21, 2009. Six-inch diameter core samples were taken by MnROAD personnel a few days prior. At the time of the site visit, the driving lane had been subjected to 67 days of loading by the tractor/trailer between December 16, 2008, and May 19, 2009, with 3,092 passes of the 80 kip vehicle. The weather conditions, following construction in October 2008, were typical of the winter/spring season in Minnesota. Below-freezing (-32°F) temperatures began in mid-November. Below 0°F conditions occurred in mid-December and continued sporadically through February, with occasional temperatures below 0°F in March also. Typical daytime temperatures from December through February were in the range of 10° to 30°F . In April and May, daily temperatures climbed to the 40° to 70°F range. There were two periods of temperatures above 80°F , one in late April and one in mid-May.

The second visit was on June 16, 2010. Between the May 2009 visit and the second visit, the driving lane had been subjected to 119 days of loading by the tractor/trailer. The weather conditions between May 2009 and June 2010 were typical for Minnesota. Below-freezing (-32°F) temperatures began the beginning of November and continued through the end of March.

The third visit was on June 2, 2011. Core samples were collected the day of the site visit by the MnROAD staff at locations three feet east of the 2009 sample locations. Between the June 16, 2010, visit and the third visit the driving lane had been subjected to 156 days of loading by the tractor/trailer. The weather conditions between June 2010 and June 2011 were typical for Minnesota. Below-freezing (-32°F) temperatures began the third week of November and continued through the end of April.

Field Condition Survey Background

A visual inspection of the surface was conducted during each of the site visits. A qualitative condition survey was taken based on visual observation each year to help better define and investigate the change of functionality of this pervious concrete pavement under highway traffic loading with service time. According to the visual observations from the year of 2009 (Figure 62), 2010 (Figure 63), and 2011 (Figure 64), the pavement distresses that occurred to this pervious concrete pavement can be primarily classified into five categories: (1) joint deterioration, (2) stretch marks, (3) surface sealing, (4) de-bonding, and (5) cracking. The initial condition survey from 2009 is shown in Figure 62. As shown in Figure 62, the lower half of the cell represents the environmental lane, which is not subject to traffic, and the upper half of the cell represents the traffic lane, which is subject to tractor/trailer traffic.

A majority of the observed pavement distresses are joint deterioration and stretch marking. The areas labeled low density can be considered entire stretch-marked panels. These two types of failures were observed in over two-thirds of the panels. Stretch marks were present during placing and caused by construction, while most joint deterioration occurred during the first winter. Stretch marks are localized areas of visually observed low density. Stretch marks may or may not accompany increased raveling. At the MnROAD overlay site, no deterioration was observed around stretch mark areas. Joint deterioration is widening of the joint caused by raveling of aggregate pieces. Surface sealing is also caused by construction and present initially, but in isolated areas. Surface sealing is caused by excess mixture water, allowing the paste to clog the surface voids. The fourth pavement distress of debonding is more difficult to identify with pervious concrete. It was observed that the corners indicated in Figure 62 had visual movement when compressed. A sounding was performed across the entire cell, indicating possible significant debonding. However, sounding performed on full-depth pervious concrete, where no debonding was possible, indicated difficulty in identifying the appropriate baseline for pervious concrete. The suspected debonded areas were monitored for any cracking or other deterioration. Finally, a few transverse cracks and one long longitudinal crack were observed.

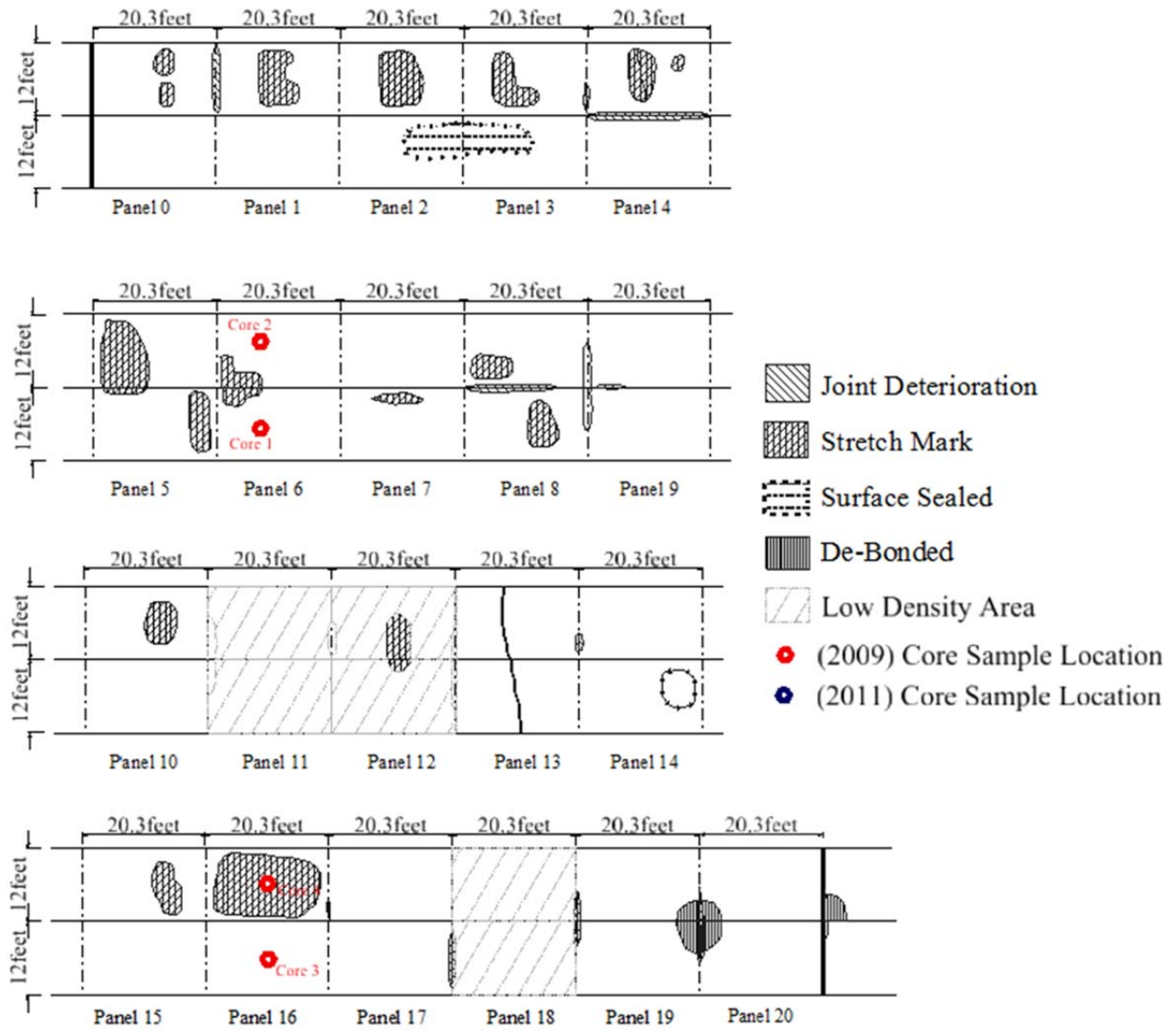

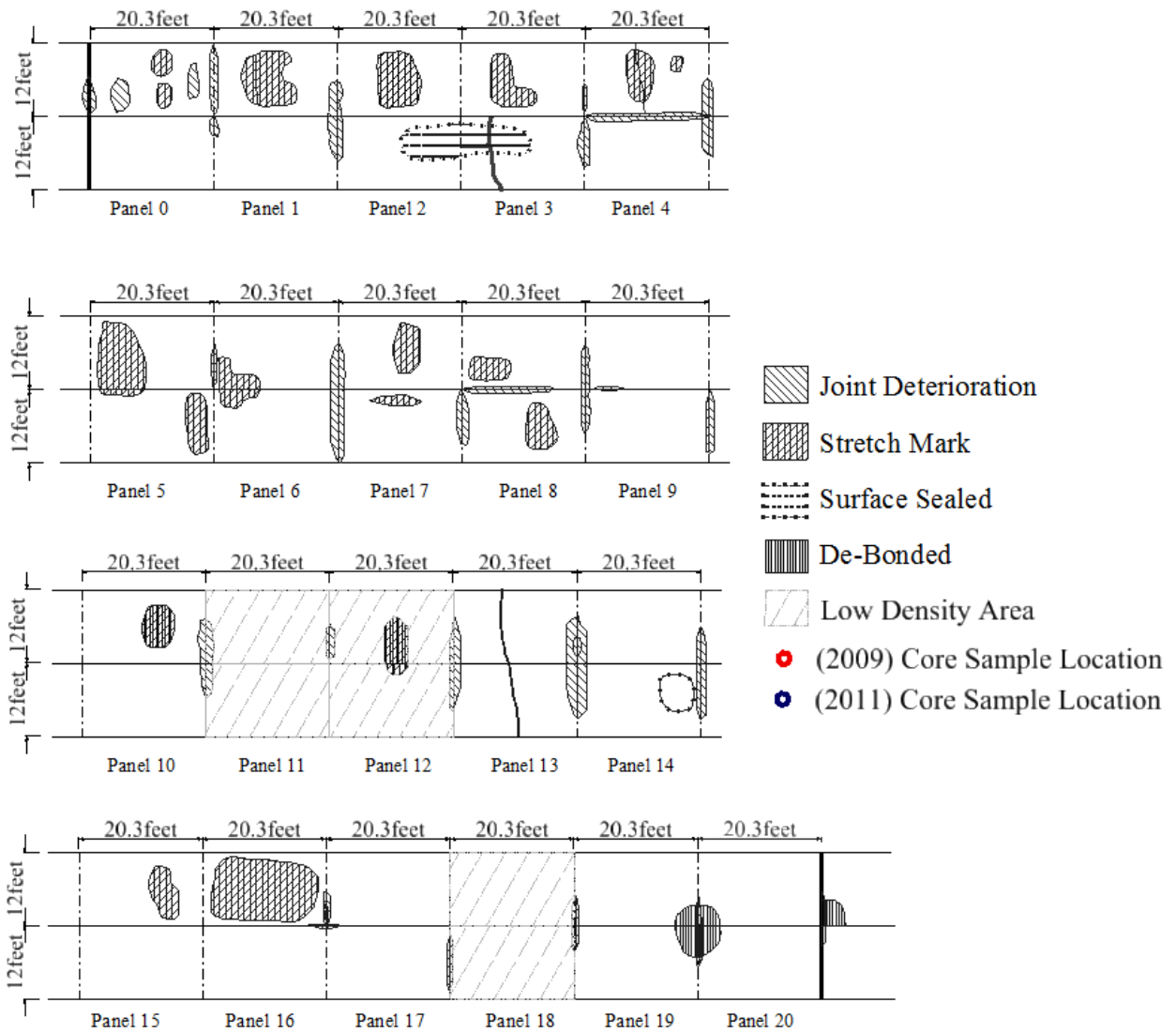

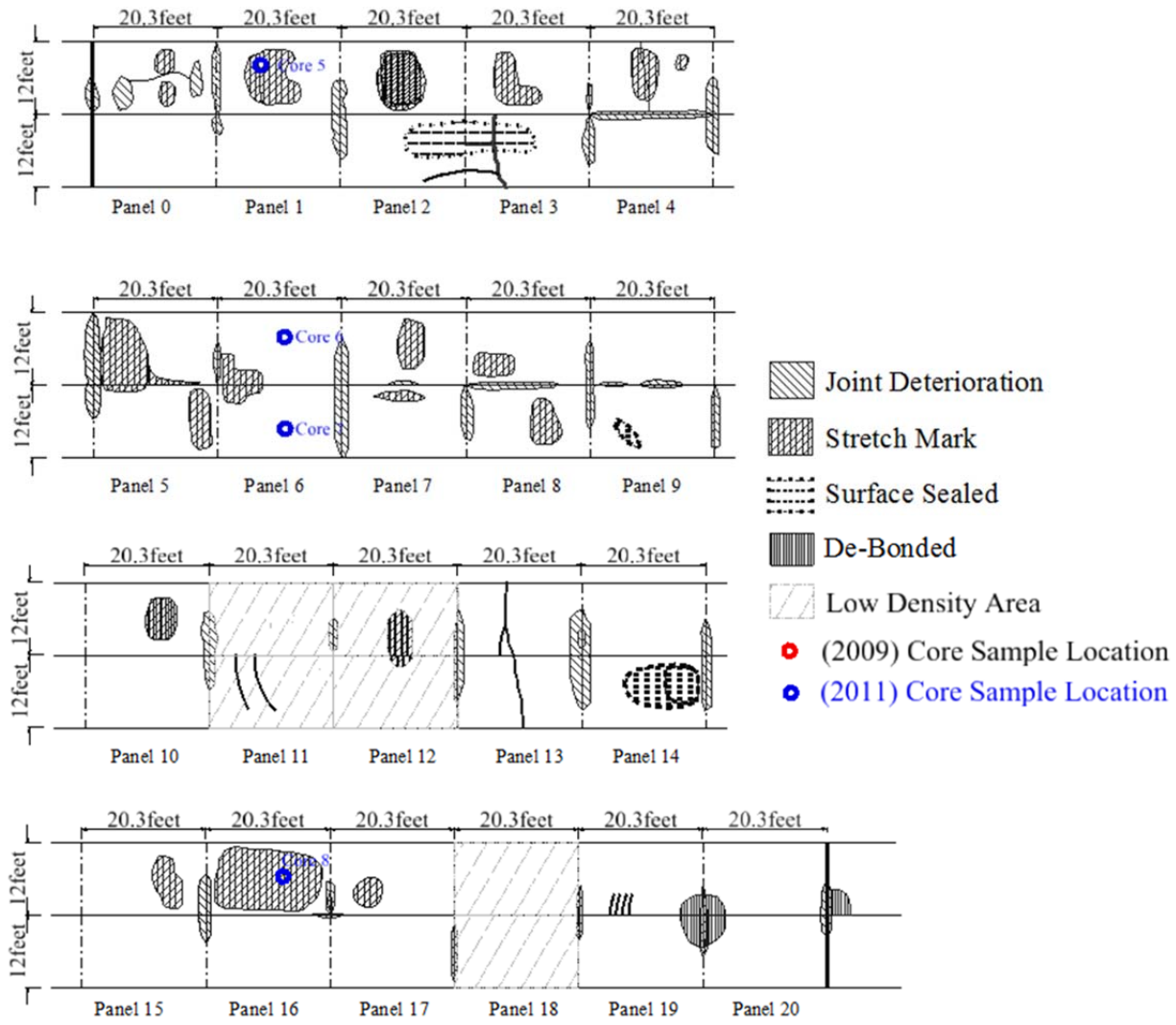

Figure 64. 2011 condition survey

Observed Defects and Distresses

Joint Deterioration

Joint deterioration is observed primarily along transverse joints; very little joint deterioration was observed in longitudinal cracks.

Table 30 shows the observed joint deterioration for 2009, 2010, and 2011. Some level of joint deterioration was observed on half of the joints, for a total of 22 joints among 20 panels. The severity level of each joint was defined in terms of the width of spalling or faulting within 0.6 m of the construction joint (FHWA 2003). Based on the observation in 2009, five out of 22 joints showed the apparent joint deterioration, which also can be characterized as the moderate severity level because of the width of observed spalling less than 75 mm or 0.25 ft within the distance of

0.6 m from the joint. According to the observation in 2010, the number of joints with moderate severity of deterioration increased to 13 out of 22, including the three from 2009 that showed the “moderate” severity. Observation in 2011 showed more than 15 joints were observed, with the apparent deterioration characterized as moderate severity. Approximately one or two joints were classified as high severity because of the very severe spalling of concrete occurring as shown in Figure 65.

A majority of the joint deterioration was observed two years after construction. During the 2009 field inspection, it was noted that many joints had filled with debris, which can be seen in the left image of Figure 65. However, field inspections in 2010 and 2011 observed the joints were relatively free of loose material, possibly from rain and traffic loading. Joints free of loose material were more likely to be recorded than those filled. It appears that joint deterioration progresses from significant loss of materials as raveling occurs to more open clean joints afterward. Figure 65 shows a joint in the early stages of raveling on the left in 2009 and much cleaner on the right in 2011. Even though joint deterioration was moderate to severe for less than 50% of the joints, the joints from Panels 15 to 20 were in excellent condition, with little deterioration in 2011.



Figure 65. High severity level joint deterioration

Table 30. Observed joint deterioration

Joint Deterioration Occurrence	2009	2010	2011
Overall Observed	Between P-0 and P-1; P-8 and P-9; P-13 and P-14; P-17 and P-18; P-18 and P-19; south lane and north lane of P-4;	Between P-0 and P-1; P-1 and P-2; P-3 and P-4; P-4 and P-5; P-6 and P-7; P-8 and P-9; P-10 and P-11; P-12 and P-13; P-13 and P-14; P-14 and P-15; P-17 and P-18; P-18 and P-19; south lane and north lane of P-4 and P-8;	Almost all the joints were observed as having joint deteriorations with various levels of severity
Noticeable Developments From Last Year	-	Between P-0 and P-1; P-10 and P-11; P-13 and P-14;	P-4 and P-5; P-8 and P-9; south lane and north lane of P-8 and P-5;
Newly Observed in This Year	-	P-1 and P-2; P-3 and P-4; P-4 and P-5; P-6 and P-7; P-9 and P-10; P-10 and P-11; P-12 and P-13; P-13 and P-14; P-14 and P-15; south lane and north lane of P-8;	-

Stretch Mark

Stretch marking is a surface defect from construction that was prevalent but did not correlate to increase in any of the other distresses. A stretch mark occurs in construction when a sufficient head of fresh concrete is not kept in front of the placing equipment, resulting in a surface depression and area of higher porosity. Figure 66 shows a severe stretch mark area.



Figure 66. Stretch mark example

Sealed Surface

Surface sealing occurs when the surface pores become filled with cement paste. Surface sealing may occur from too much water or cement paste in the mixture, incorrect gradation for the amount of cement paste, improper vibration during placement, or, most commonly, finishing water applied to the fresh concrete surface. Surface sealing is primarily a surface defect without any associated durability issues. However, surface sealing decreases infiltration rate of the top surface of pervious concrete pavement. Figure 67 shows surface sealing found on Panel 9. As observed, the open structure was filled up with extra paste. Figure 67 shows typical surface sealing where the lighter colored area is impervious. Surface sealing is usually limited, and water runs off into nearby functional areas.



Figure 67. Surface sealed on Panel 4 by wet mixture or over compaction

Longitudinal Crack

A single longitudinal crack was first observed in 2011, which went from Panel 0 and reached an approximate length of 80 ft or 25 m, as shown in Figure 68. According to Huang (1993), this observed longitudinal crack may be characterized as moderate severity due to the crack width being less than 13 mm. Typically, concrete overlay panel sizes are much smaller than the underlying jointing to reduce stress and prevent debonding. The pervious concrete panels were kept the same as the original pavement to observe location of fatigue cracking. The observed longitudinal crack may suggest fatigue cracking from the cumulative loading.



Figure 68. Longitudinal crack from heavy vehicles or loading repetitions

Transverse Crack

Transverse cracks were also observed on Panels 3, 11, 13, and 19. A transverse crack existed in the underlying pavement in Panel 13 that matched the crack reflected in the pervious concrete overlay observed first in 2009. Overall, little additional transverse cracking was observed in addition to Panel 13 (Table 31). For each individual cracking, the severity levels were also determined according to Huang (1993) in terms of cracking width.

Table 31. Transverse crack developments in years of 2009, 2010, and 2011

Transverse Cracking Occurrence	2009	2010	2011
Overall Observed	P-13	P-3; P-13;	P-3; P-11; P-13; P-19
Noticeable Developments	-	P-13	P-3; P-13;
Newly Observed in This Year	-	P-3	P-11; P-19;
Severity Level Determination			
P-3	-	No observation	Moderate
P-13	Moderate	High	High
P-11	-	-	Low
P-19	-	-	Low

Uniquely, the cracking on Panel 3 shown in Figure 69 was well formed across the entire south panel. Transverse cracking on Panels 11 and 19 was not complete with low severity. The instances of transverse cracking, other than Panel 13, all occur approximately 2 to 3 ft. (0.6–1.0 m) from the joint, suggesting debonding near the formed joint.

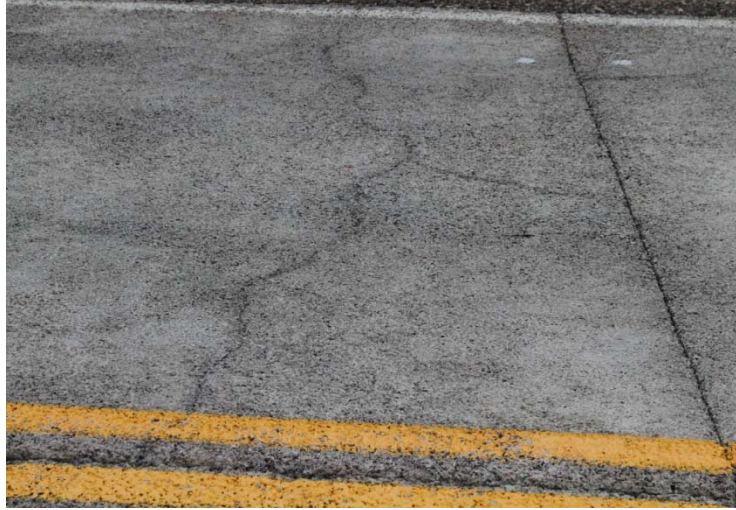

Figure 69. Transverse cracking on Panel 3

Summary of the Condition Surveys

Table 32 provides a summary of the pavement condition by panel and year. Surface sealing and stretch marking were observed initially after construction and did not progress, worsen, or result in any additional deteriorations. Generally, joint deterioration changed most between the first and second years. Cracking was not observed initially and has only been noted in the third year.

Table 32. Condition survey interpretation

Panel No.	Year		
	2009	2010	2011
P-0	Stretch marking was observed on a small portion of south lane of Panel 0, and the joint deterioration between Panels 0 and 1 was observed.	The area of stretch marking increased on northern side of Panel 0. A very small new joint deterioration was noted.	A narrow longitudinal crack was observed on the northern slab.
P-1*	Stretch marking was observed on 30% of south lane of Panel 1 area. A 6 in. diameter core sample was taken.	No noticeable new crack or pavement failures were found.	No noticeable new crack or pavement failures were found.
P-2*	Surface sealed was observed on 30% of Panel 2 area. The joint between Panels 1 and 2, and 2 and 3 was observed in excellent condition.	No noticeable new crack or pavement failures were found.	No noticeable new crack or pavement failures were found.
P-3*	Stretch marking was observed on 30 of Panel 3.	A transverse crack was observed on southern portion of Panel 3.	A longitudinal crack was observed on southern slab of Panel 3 from Panel 2.
P-4	Stretch marking and joint deterioration were observed.	A narrow transverse crack was observed developing on the northern side of Panel 4. Joint deterioration was observed between Panels 4 and 5.	No noticeable new crack or pavement failures were found.
P-5	Large areas of stretch marking observed on both north and south lanes of Panel 5.	No noticeable new crack or pavement failures were found.	Joint deterioration was observed between Panel 5 and Panel 4. The majority of the deterioration was on northern side.

P-6	Stretch marking was observed, and four core samples were taken from Panel 6, two from each lane.	No noticeable new crack or pavement failures were found.	No noticeable new crack or pavement failures were found.
P-7	Panel noted in good condition with a small area of stretch marking on south lane.	Joint deterioration observed between Panels 6 and 7.	No noticeable new crack or pavement failures were found.
P-8	Stretch marking was observed on both lanes, and the joint between south and north slab.	A joint deterioration was noted between Panels 7 and 8.	No noticeable new crack or pavement failures were found.
P-9	Panel 9 was observed in condition with a small amount of joint deterioration between southern and northern slab.	No noticeable new crack or pavement failures were found.	Surface sealing first observed on southern side.
P-10	A small area of stretch mark was observed on northern slab of Panel 10.	No noticeable new crack or pavement failures were found.	No noticeable new crack or pavement failures were found.
P-11	Panel noted in good condition.	A joint deterioration was observed between Panels 10 and 11.	Two transverse cracks were observed under development, starting from the centerline toward the edge of the pavement.
P-12*	A small area of stretch marking on south slab of Panel 12 was observed. A core sample was taken from the southern slab.	A joint deterioration was observed between Panels 11 and 12.	No noticeable new crack or pavement failures were found.
P-13*	Transverse crack was observed.	A small crack was noticed developing originally from the previous existing traverse crack.	No noticeable new crack or pavement failures were found.
P-14	Surface sealing was observed on southern slab of Panel 14.	No noticeable new crack or pavement failures were found.	No noticeable new crack or pavement failures were found.

P-15*	Joint deterioration was observed on northern slab.	The length and severity of joint deterioration developed based on the condition from last year.	A short length of joint deterioration was newly found developing between Panels 15 and 16.
P-16	A large area of stretch marking was observed on northern side of Panel 16. The area of stretch marking is about 80% to 90% of total northern slab area.	No noticeable new crack or pavement failures were observed.	No noticeable new crack or pavement failures were observed.
P-17*	Panel noted in good condition with a small length of joint deterioration.	No noticeable new crack or pavement failures were found.	No noticeable new crack or pavement failures were observed.
P-18*	Panel noted in good condition.	No noticeable new crack or pavement failures were found.	A series of narrow and parallel transverse cracks were observed developing from the centerline toward the edge of pavement on northern lane.
P-19	Panel noted in good condition. A short length of joint deterioration was observed between Panels 19 and 20. At the same spot of joint deterioration, the stretch mark and de-bond were also observed.	No noticeable new crack or pavement failures were found.	No noticeable new crack or pavement failures were observed.
P-20*	Panel surface in good condition, but with a de-bonded existing.	No noticeable new crack or pavement failures were found.	No noticeable new crack or pavement failures were found.

Discussion of Condition Survey Results with Consideration for Construction Practices

Several of the surface defects and deteriorations were directly related to the construction practices and can serve as lessons for all future pervious concrete projects. The transverse joints

were installed using a rolling pizza cutter device. Longitudinal joints were flat butts to the forms of the existing slab for the second pour. Joint deterioration was only significantly observed on the formed transverse joints. The joint-forming process involves pressing the fresh concrete away from the rolling tool to form a crease. The joint-forming tool was inserted on one side, pushed across, then pulled back over a pre-marked chalk line. It was observed that the tool often did not follow the same track when pulled back and disturbed fresh particles that were left loose on the pavement surface. Figure 70 shows one joint where the two passes clearly produced two tracks, a wide joint, and loose particles. Durability of these large joints may also have been affected by construction workers attempting to fix the loose particles. In Figure 71 a worker is troweling the inside of a joint that later experienced severe deterioration.

While stretch marking did not result in increased distresses or deterioration, visually the pavement texture was inconsistent and may not be acceptable for an owner. Figure 71 shows stretch marking as the paver began. The triple-tube type paver used on the overlay project was difficult to reverse for refinishing, so stretch marked areas from the initial pass were generally paid little attention.



Figure 70. Example of double-jointing



Figure 71. Observation of stretch marking on fresh pavement

Typically concrete overlay joints are saw cut through the overlay into the existing pavement to reduce the likelihood of debonding due to thermal and traffic stresses. Because the joint in the pervious concrete overlay was formed only to a partial depth, uncracked joints and resulting aggregate interlock would have resulted in significantly increased bond stress near the joint. The forming process only located the overlay joint approximately over the existing joint, which could also increase bond stresses between the two slabs. Figure 72 shows an example of a formed joint not exactly straight over the original slab. Moistening the surface of the existing concrete was recommended to provide good bond quality. Figure 73 shows one instance where fresh concrete was placed directly into water pooled on the concrete surface. In this instance the pooled water is located on a joint, which may attribute to future debonding.



Figure 72. Jointing on fresh pavement



Figure 73. Pooled water before placement

Flow Characteristics

Flow of water through the surface pervious concrete was determined by conducting field infiltration tests using an NCAT AP-1B Field Permeameter (Gilson 2011) in 2009, 2010, and 2011. In 2010 and 2011, infiltration was performed according to ASTM C1701 (2009). Infiltration testing was conducted at the same location. Tests were conducted in five locations. One of the tests was conducted near the center of the cell, in the south (driving) lane. The other four tests were conducted in close proximity to the core samples (within 3 ft [1 m]). The field infiltration values reported in Table 33 for 2009 are the average of five to seven trials. Testing locations were selected to represent visually one area at a lower surface porosity, one area at a higher surface porosity, and three areas of typical surface porosities. Table 33 shows that the infiltration for the pervious concrete overlay varied from about 230 in./hr to 3,000 in./hr, a factor of over 10. The low end of the flow results shows that the pervious concrete contains sufficient flow capacity to remove stormwater from the pavement. All of the field infiltration tests were conducted in the middle of panels, and the time for water to flow from the test area to the edge of the pavement, generally, a distance of six to seven feet, was two to three minutes for the north lanes of Panels 6 and 16 to 15 minutes for the south lane of Panel 6. These observations indicate that good lateral flow capacity exists in the overlay.



Figure 74. NCAT infiltration test device (2009)

The core samples were taken back to the laboratory and tested using previously described techniques for permeability and porosity (Kevern 2006). The resulting permeability results are shown in Table 33. Comparisons to the field permeability results in proximity to the core locations show that the field values are much higher than the laboratory values, ranging from ratios of 2 to 3 up to 23 times higher. The difference is likely due to scale effects between permeability and infiltration. For the field infiltration testing, a much larger unknown volume of pervious concrete is tested, compared to a smaller known volume in the laboratory. The highest difference occurred in the lowest permeable core sample, further indicating the scale effects on less porous samples. However, even at the low value of 10 in./hr determined in the laboratory, the pervious concrete overlay would possess sufficient flow capacity to move water under most storm events.

Discussions with the tractor/trailer operator about observations during rain events yielded the comments that the surface of the pervious concrete overlay drains the rainwater away immediately, that no ponding of water occurs, and the water can be seen running off to the sides of the pavement. Observations from water poured near the core locations indicated that there was good lateral flow capacity, as seen in Figure 75.

Table 33. Infiltration and permeability of pervious concrete overlay 2009

Sample Location	Porosity (%)	Field Infiltration n./hr (cm/s)	Core Sample Laboratory Permeability in./hr (cm/s)
Panel 12 South Lane (Env)		1200 (0.85)	
Panel 6 South Lane (Env)	26.2	1100 (0.78)	290 (0.20)
Panel 6 North Lane (Drive)	28.9	2150 (1.52)	590 (0.42)
Panel 16 South Lane (Env)	19	230 (0.16)	10 (0.007)
Panel 16 North Lane (Drive)	37.3	3000 (2.11)	1600 (1.13)



Figure 75. Overlay bonding

The 2010 field testing results are shown in Table 34. No core samples were taken in 2010. The new ASTM C1701 test was conducted during this site visit. All NCAT values were similar to the 2009 tests, with the exception of the visually selected low section in Panel 16. The NCAT method uses a much larger starting head value and consistently produced rates 3–4 times greater than the ASTM C1701 method. The infiltration and permeability values from 2011 are shown in Table 35. Field values are consistent with previous years and indicate no clogging or any reduction in initial permeability.

Table 34. Infiltration of pervious concrete overlay 2010

Sample Location	NCAT Field Infiltration in./hr (cm/s)	ASTM C1701 Field Infiltration in./hr (cm/s)
Panel 12 South Lane (Env)	1260 (0.89)	338 (0.24)
Panel 6 South Lane (Env)	1000 (0.70)	280 (0.20)
Panel 6 North Lane (Drive)	1860 (1.31)	600 (0.42)
Panel 16 South Lane (Env)	43 (0.03)	66 (0.05)
Panel 16 North Lane (Drive)	3680 (2.60)	1080 (0.76)

Table 35. Infiltration and permeability of pervious concrete overlay 2011

Sample Location	Porosity (%)	Field Infiltration		Core Sample Laboratory Permeability in./hr (cm/s)
		NCAT in./hr (cm/s)	ATSM C1701 in./hr (cm/s)	
Panel 12 South Lane (Env)		910 (0.64)	122 (0.09)	
Panel 6 South Lane (Env)	24.8	750 (0.53)	266 (0.19)	640 (0.45)
Panel 6 North Lane (Drive)	23.6	1200 (0.85)	456 (32)	1320 (0.93)
Panel 16 South Lane (Env)	21.1	330 (0.23)	37 (0.03)	210 (0.15)
Panel 16 North Lane (Drive)	35.2	7330 (5.20)	1940 (1.40)	4020 (2.83)

Summary of Condition Survey Results

The pervious concrete overlay has been in place at the MnROAD LVR since October of 2008. Field condition surveys were performed in June of 2009, 2010, and 2011. Investigation of its condition reveals localized pavement distresses, but overall good performance and durability. The concrete mixture was designed for slip-form mechanized placement, and the observed distresses are related to the selected method of construction, which was hand placement using a roller-screed. A higher degree of construction consistency would have been expected using mechanized placement.

The flow characteristics of the pervious overlay were investigated using both field and laboratory permeability tests. Both vertical and lateral flow characteristics were investigated and showed that the pavement possesses more than adequate flow to handle storm events and prevent surface ponding. Operations during rain events indicate that the pervious overlay quickly removes rainwater from the pavement surface and that the water migrates laterally to the side of the pavement. These results indicated pervious concrete is a successful tool for mitigating splash and spray and reducing hydroplaning difficulties.

CHAPTER 12. OVERLAY NOISE CHARACTERISTICS

Introduction

Constructing quiet pavement is an increasingly important goal, especially in urban areas. The interaction between the tire and the pavement is the critical noise element for operating speeds greater than 20 mph. Noise is measured in decibels (dB), which is a measure of the small air pressure fluctuations that make up sound. The units of noise are most often reported as dBA to reflect the sound levels being reported as A-weighted. Most people cannot perceive a change of 1 to 3 dBA unless the sounds are heard consecutively. Tire-pavement noise measurements, where microphones are located on a rolling tire just a few inches from the pavement, are called on-board sound intensity (OBSI) measurements. Typically, traditional concrete pavement noise levels range from about 100 dBA to 111 dBA (Ferragut et al. 2007).

On-board sound intensity testing was performed according to AASHTO TP76 *Standard Method of Test Measurement of Tire/Pavement Noise Using the On-Board Sound Intensity (OBSI) Method* (AASHTO 2010). Measurements of OBSI are performed using a standard tire at 60 mph and averaging leading- and trailing-edge microphone sound intensity. A test setup schematic is shown in Figure 76 with a test image shown in Figure 77.

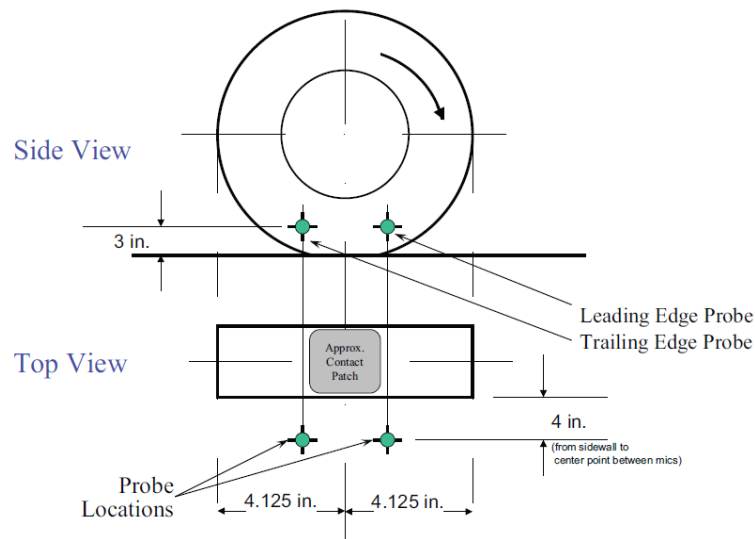

Figure 76. Sound intensity probe positions with respect to the tire-pavement interface (Rasmussen et al. 2011)



Figure 77. OBSI configuration with dual sound intensity probes (Rasmussen et al. 2011)

Because tire-pavement noise is the dominant element of highway noise, controlling pavement texture is the most important characteristic to impact noise levels. Figure 78 shows sound intensity distributions for traditional concrete pavement surfaces. Noise levels less than 100 dBA are considered quiet pavements. It is critical to have negative (downward pointing) texture to achieve a quiet concrete pavement (Rasmussen et al. 2008). Pervious concrete has the advantage of exhibiting this negative, open texture, and the measured noise levels reflect that texture.

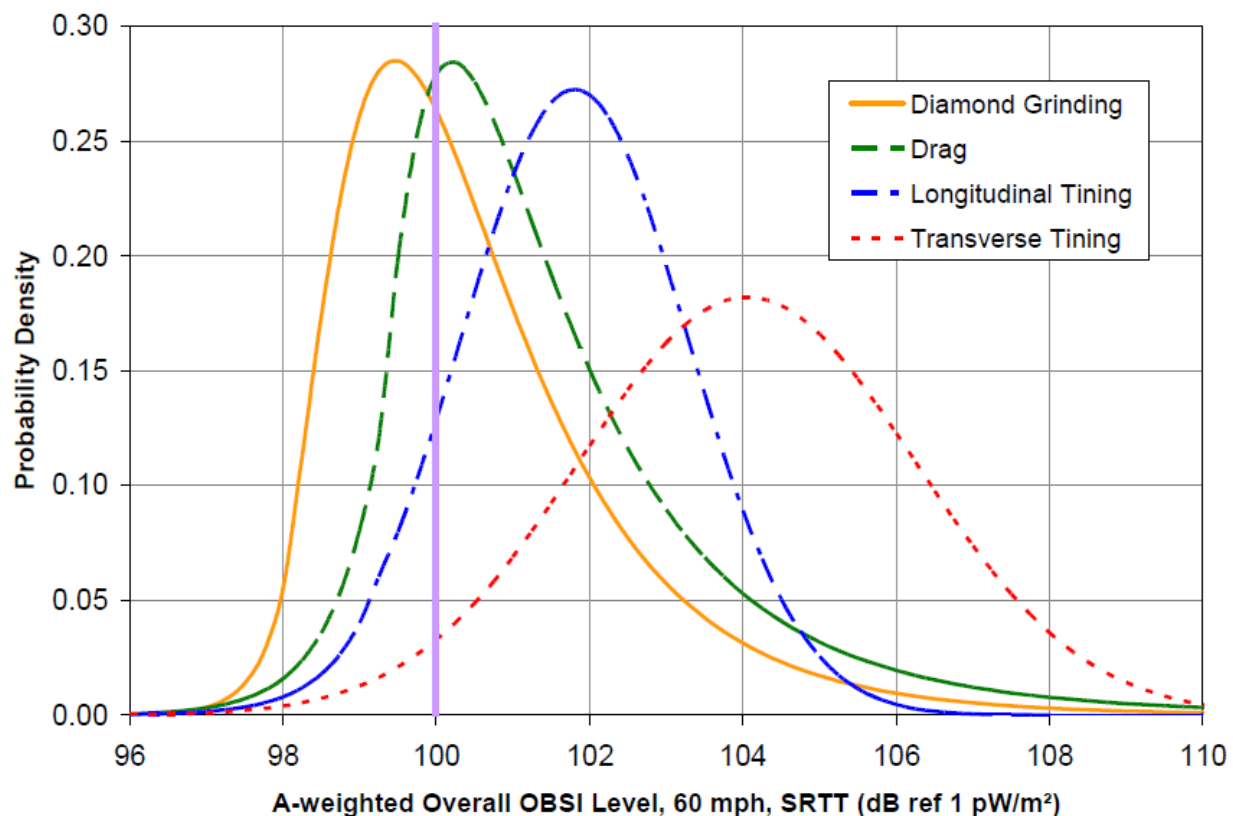

Figure 78. Normalized distributions of OBSI noise levels for conventional pavement textures (Rasmussen et al. 2008)

Sound Intensity Testing Results

Noise reduction is one of the advantages of pervious concretes and a primary reason for developing a pervious concrete overlay. A 10 dBA change in noise represents a doubling of perceived sound for the same sound. The pervious concrete overlay in Cell 39 has been subject to ongoing noise studies by MnDOT using OBSI equipment. The equipment and the noise studies at MnROAD are further described by Izevbekhai et al. (2008). Three trials conducted in March 2009 on the driving (outside) lane of Cell 39 resulted in an average OBSI reading of 98 for the pervious concrete overlay—among the quietest of concrete pavements. Test runs on the environmental lane (outside, south lane) and the traffic lane (inside, north lane) in July 2009 showed noise intensity in the low 90s. The variation of intensity with frequency for July 22, 2009, test runs along Cell 39 is shown in Figure 79. The peak intensity for the traffic lane is 96.0 dBA, and for the environmental lane the peak intensity is 92.4.

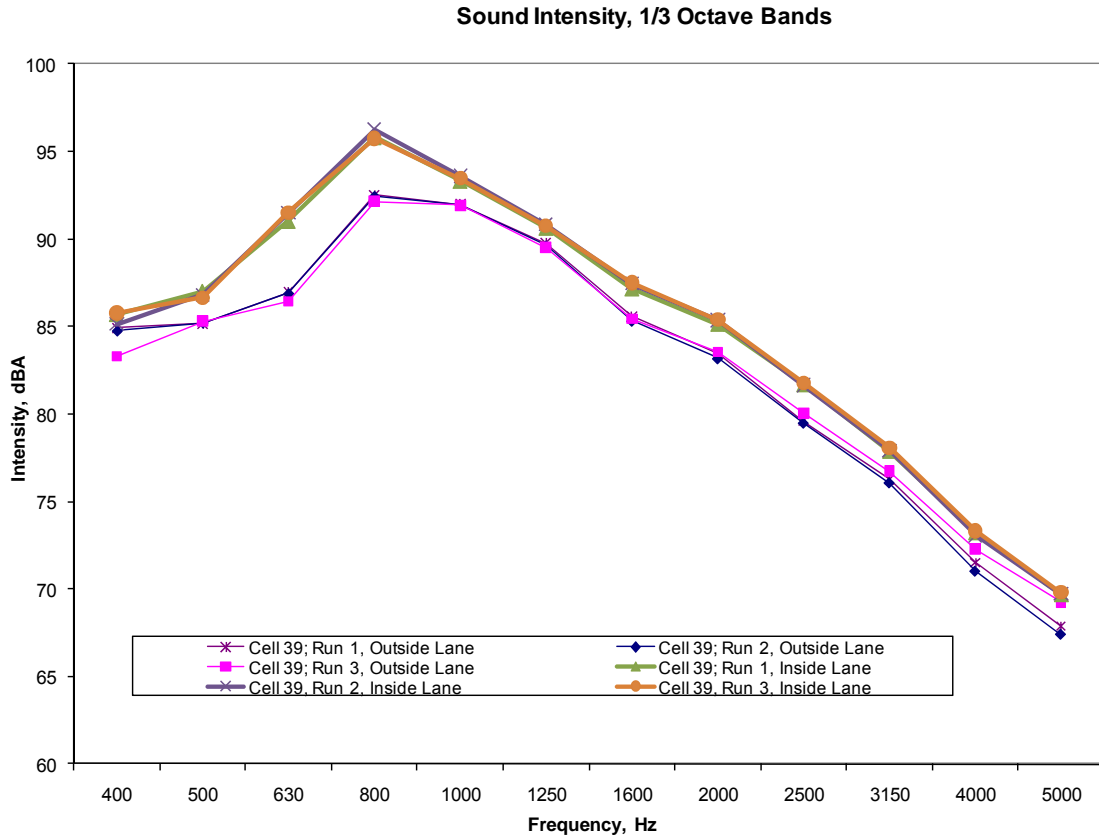

Figure 79. Frequency versus intensity for Cell 39, outside environmental lane and inside traffic lane, July 22, 2009

The noise measurements conducted in March and July of 2009 reveal a remarkably quiet pavement with OBSI values in the 90 dBA range. The driving lane showed OBSI values of 98 dBA in March and 96 dBA in July. There is about a 4 dBA difference in intensity between the environmental lane and the traffic lane, with the environmental lane quieter. The pervious concrete overlay on Cell 39 of MnROAD has been tested by MnDOT and as a part of the Concrete Pavement Surface Characteristics Program (CPSCP) at the National CP Tech Center at ISU. Table 36 shows the results of several different tests.

Table 36. OBSI test results

Agency	Date	Noise Level (dBA)
MN DOT	March 2009	98
MN DOT	July 2009	96
CPSCP	2009	98.1
CPSCP	July 2010	98.5

Sound Intensity Conclusions and Recommendations

While more investigation is necessary, as shown in Figure 62, Figure 63, and Figure 64, material properties differed from the two placements. The quieter environmental lane had generally a better surface condition and lower permeability than the concrete located in the drive lane. However, even considering the surface distresses described in Chapter 11, the low noise intensity values for both lanes bode well for the use of pervious concrete as an overlay in urban areas. As indicated by these results, the pervious concrete overlay is a very quiet concrete pavement. Improved construction consistency to enhance surface consistency and minimize surface distresses would likely result in an even quieter pavement. Results show a pervious concrete overlay would be an effective method to address tire-pavement noise in urban areas.

CHAPTER 13. CONCLUSIONS AND FUTURE RESEARCH

A comprehensive study was undertaken to investigate the use of PCPC in overlay applications. The first part of the study involved a combination of fundamental property investigations, test method developments, and overlay design and constructability issues. With answers to questions about appropriate properties, design, and construction, a pervious concrete overlay was designed and constructed at the MnROAD Low Volume Road. This overlay represented the first wet-on-dry concrete overlay and has been in place for over three years. The overlay has been a success and is performing remarkably well in regard to its surface durability, hydraulic performance, and low noise.

Specific conclusions are drawn at the end of each chapter and are summarized in the Executive Summary.

Future Research

This research project answered many questions surrounding pervious concrete construction and applications. The mixture design was a success. Areas were identified in the construction process that resulted in a less-than-optimal final project. A logical next step is to construct a pervious concrete overlay for use as a general roadway application, improving on this research project. Like any new technology, limited publically accessible trial sections must be constructed to prove to state and municipal owners that the technology is durable and viable in specific environmental conditions. The good performance in a particularly harsh freeze-thaw climate, Minnesota, shows pervious concrete is durable and can be used in freeze-thaw climates with truck traffic and heavy snow plowing.

Future related research of particular interest would be addressing design requirements for minimized clogging in particular areas and observing constructed sections. Long-term noise generation is also an area of interest, with investigation into wear and normal surface deterioration impacts on surface characteristics. This project was designed for slip-form paving, which did not end up occurring. Mechanized placement should produce a more uniform final surface and improve overall durability. A logical next step would be to use mechanized placement.

REFERENCES

- American Association of State Highway Transportation Officials (AASHTO). 2010. *Standard Method of Test for Measurement of Tire/Pavement Noise Using the On-Board Sound Intensity (OBSI) Method*. AASHTO Specification TP 76-10.
- American Concrete Institute (ACI). 2000. Standard practice for curing concrete. *ACI 3089-2*. Detroit, Michigan.
- American Concrete Institute (ACI). 2010. Pervious Concrete. *522-R10: ACI 522 Committee Report*. Farmington Hills, Michigan: ACI.
- Amer, N., N. Delatte, and C. Storey. 2003. Using gyratory compaction to investigate density and mechanical properties of roller-compacted concrete. *Transportation Research Record*, Paper No. 03-3120.
- Asphalt Institute (AI). 2001. Superpave mix design. *Superpave Series No. 2 (SP-2)*. Lexington, Kentucky: Asphalt Institute.
- ASTM, Standard C-33, "Standard Specification for Concrete Aggregates," *Annual Book of ASTM Standards* Vol. 4(2), ASTM International, West Conshohocken, PA: ASTM International, 2003.
- ASTM Standard C39. 2003. Standard test method for compressive strength of cylindrical concrete specimens. *Annual Book of ASTM Standards* 4 (2). West Conshohocken, Pennsylvania: ASTM International.
- ASTM Standard C78. 2002. Standard test method for flexural strength of concrete (using simple beam with third point loading). *Annual Book of ASTM Standards* 4 (2). West Conshohocken, Pennsylvania: ASTM International.
- ASTM Standard C94. 2003. Standard specification for ready-mixed concrete. *Annual Book of ASTM Standards* 4 (2). West Conshohocken, Pennsylvania: ASTM International.
- ASTM Standard C109. 2003. Standard test method for compressive strength of hydraulic cement mortars (using 2-in. or [50-mm] cube specimens). *Annual Book of ASTM Standards* 4 (2). West Conshohocken, Pennsylvania: ASTM International.
- ASTM Standard C192. 2003. Standard practice for making and curing concrete test specimens in the laboratory. *Annual Book of ASTM Standards* 4 (2). West Conshohocken, Pennsylvania: ASTM International.
- ASTM Standard C215. 2003. Standard test method for fundamental transverse, longitudinal, and torsional resonant frequencies of concrete specimens. *Annual Book of ASTM Standards* 4 (2). West Conshohocken, Pennsylvania: ASTM International.
- ASTM Standard C457. 1998. Standard test method for microscopical determination of parameters of the air-void system in hardened concrete. *Annual Book of ASTM Standards* 4 (2). West Conshohocken, Pennsylvania: ASTM International.
- ASTM Standard C496. 2003. Standard test method for splitting tensile strength of cylindrical concrete specimens. *Annual Book of ASTM Standards* 4 (2). West Conshohocken, Pennsylvania: ASTM International.
- ASTM Standard C617. 2003. Standard practice for capping cylindrical concrete specimens. *Annual Book of ASTM Standards* 4 (2). West Conshohocken, Pennsylvania: ASTM International.
- ASTM Standard C666. Standard test method for resistance of concrete to rapid freezing and thawing. *Annual Book of ASTM Standards* 4 (2). West Conshohocken, Pennsylvania: ASTM International.

- ASTM Standard C672. 2003. Standard test method for scaling resistance of concrete surfaces exposed to deicing chemicals. *Annual Book of ASTM Standards* 4 (2). West Conshohocken, Pennsylvania: ASTM International.
- ASTM Standard C944. 2005. Standard test method for abrasion resistance of concrete or mortar surfaces by rotary-cutter method. *Annual Book of ASTM Standards* 4 (2). West Conshohocken, Pennsylvania: ASTM International.
- ASTM Standard C1701. 2009. Standard test method for infiltration rate of in place pervious concrete. *Annual Book of ASTM Standards* 4 (2). West Conshohocken, Pennsylvania: ASTM International.
- Bax, N., A. van Duerzen, and A. Molenaar. 2007. New technique for rapid construction and rehabilitation of concrete pavements. Pp. 283–293. In *Proceedings of the International Conference on Optimizing Paving Concrete Mixtures and Accelerated Concrete Pavement Construction and Rehabilitation*. Federal Highway Administration (FHWA), Atlanta, Georgia.
- Bean, E. Z., W. F. Hunt, and Bidelspach, D.A. 2007. Field survey of permeable pavement surface infiltration rates. *Journal of Irrigation and Drainage Engineering* 133 (3, June).
- Beeldens, A. 2001. *Behavior of Porous PCC under Freeze-Thaw Cycling*. Paper presented at the Tenth International Congress on Polymers in Concrete, Honolulu.
- BRITE/EURAM PROJECT BE 3415. 1994. *Surface Properties of Concrete Roads in Accordance with Traffic Safety and Reduction of Noise, State-of-the-Art Report and Recommendations for Proactive and Further Developments*. 102 pp.
- Chopra, M., S. Kakuturu, C. Ballock, J. Spence, and J. Wanielista. 2010. Effect of rejuvenation methods on the infiltration rates of pervious concrete pavements. *Journal of Hydrologic Engineering*. ASCE, June.
- Concrete Experts International. 2002. *User's Manual RapidAir 457*. Vedbæk, Denmark. www.concreteexperts.com (12 August 2011)
- Delatte, N., D. Miller, and M. Mrkajic. 2007. *Portland Cement Pervious Concrete: Field Performance Investigation on Parking Lot and Roadway Pavements*. Final Report of the RMC Research and Education Foundation. Silver Springs, Maryland, <http://www.rmc-foundation.org/newsite/images/Long%20Term%20Field%20Performance%20of%20Pervious%20Final%20Report.pdf>
- Deo, O., M. Sumannasooriya, and N. Neithalath. 2009. Permeability reduction in pervious concretes due to clogging experiments and modeling. *Journal of Materials in Civil Engineering* 22 (7).
- Descornet, G., F. Fuchs, and R. Buys. 1993. Noise reducing concrete pavements. In *Proceedings of the Fifth International Conference on Concrete Pavements and Rehabilitation* 2:93–98. Purdue University.
- Dubberke, W. and V. J. Marks. 1985. The effects of deicing salt on aggregate durability. *Transportation Research Record* 1031:27–34.
- Federal Highway Administration (FHWA). 2003. *Distress Identification Manual for the LTPP*. Fourth Revised Edition, Federal Highway Administration, FHWA-RD-03-031, June.
- Ferguson, B. K. (2005) *Porous Pavements*. New York: Taylor and Francis Group.

- Ferragut, T., R. O. Rasmussen, P. Wiegand, E. Mun, and E. T. Cackler. 2007. *ISU-FHWA-ACPA Concrete Pavement Surface Characteristics Program Part 2: Preliminary Field Data Collection*. Report from the National Concrete Pavement Technology Center (National CP Tech Center), Ames, IA: Iowa State University, for the Federal Highway Administration, DTFH61-01-X-00042.
- Gerharz, B. 1999. Pavements on the base of polymer-modified drainage concrete. *Colloids and Surfaces A: Physicochemical and Engineering Aspects* 152:205–209.
- Gilson Company, Inc. 2011. *AP-1B Asphalt Field Permeameter Operating Instructions*. Lewis Center, Ohio: Gilson Company, Inc., April.
- Haselbach, L. M. 2010. Potential for clay clogging of pervious concrete under extreme conditions. *Journal of Hydrologic Engineering* 15 (1).
- Haselbach, L. V., S. Valavala, and F. Montes. 2006. Permeability predictions for sand clogged portland cement pervious concrete pavement systems. *Journal of Environmental Management* 81:42–49.
- Huang, Y. H. 1993. *Pavement Analysis and Design*. Prentice-Hall Publishers.
- Iowa Department of Transportation. 2000. *Test Method No. Iowa 406-C: Method of Test for Determining the Shearing Strength of Bonded Concrete*. Ames, Iowa: Iowa DOT, May.
- Iowa State University of Science and Technology (ISU). 2006. *Iowa Environmental Mesonet/Iowa State University Department of Agronomy*, <http://mesonet.agron.iastate.edu/index.phtml>
- Izevbekhai, B. I. 2008. *Construction Report of Pervious Concrete Cells in MnROAD Low Volume Road*. Minnesota Department of Transportation, December .
- Jakobsen, U. H., C. Pade, N. Thaulow, D. Brown, S. Sahu, O. Magnusson, S. De Buck, and G. De Schutter. 2006. Automated air void analysis of hardened concrete—A Round Robin study. *Cement and Concrete Research* 36:1444–1452.
- Jones, S. 2006. *Demonstration of Integrated Pervious Pavement System of Management of Stormwater Quality and Quantity*. Ames, Iowa: Iowa State University, <http://www.ctre.iastate.edu/research/detail.cfm?projectID=-1141472327> (12 August 2011)
- Joung, Y. and C. Zachary. 2008. *Evaluation and Optimization of Durable Pervious Concrete for Use in Urban Areas*. Texas Transportation Institute.
- Kevern, J. T. 2006. Mix design development for portland cement pervious concrete in cold weather climates. M.S. thesis, Iowa State University, Ames, Iowa.
- Kevern, J. T. and J. Montgomery. 2010. Hitting the targets: A case study of a pervious concrete quality assurance program. *ACI Concrete International* magazine, March.
- Kevern, J. T., K. Wang, M. T. Suleiman, and V. R. Schaefer. 2005. Mix design development for pervious concrete in cold weather. In *Proceeding of the 2005 Mid-Continent Transportation Research Symposium*. CD-ROM. Ames, IA: Iowa State University.
- Kevern, J. T., K. Wang, M. T. Suleiman, and V. R. Schaefer. 2006. Pervious concrete construction: Methods and quality control. In *Proceedings of the 2006 NRMCA Concrete Technology Forum—Focus on Pervious Concrete*. CD-ROM. Nashville, Tennessee.
- Kevern, J. T., K. Wang, and V. R. Schaefer. 2008a. *The Effect of Aggregate Type on the Freeze-Thaw Durability of Pervious Concrete*. Report sponsored by the Portland Cement Association Education Foundation.

- Kevern, J. T., V. R. Schaefer, K. Wang, and M. T. Suleiman. 2008b. Pervious concrete mixture proportions for improved freeze-thaw durability. *Journal of ASTM International* 5 (2), DOI:10.1520/JAI101320.
- Kevern, J. T., K. Wang, and V. R. Schaefer. 2008c. Self-consolidating pervious concrete. In *Third North American Conference on the Design and Use of Self-Consolidating Concrete (SCC2008)*. CD-ROM. Center for Advanced Cement-Based Materials at Northwestern University.
- Kevern, J. T., K. Wang, and V. R. Schaefer. 2008d. Pervious concrete in severe exposures development of pollution-reducing pavement for northern cities. *ACI Concrete International* (July): 43–49.
- Kevern, J. T., V. R. Schaefer, and K. Wang. 2008e. Portland cement pervious concrete: A field experience from Sioux City. *The Open Construction and Building Technology Journal* 2:82–88.
- Kevern, J. T., V. R. Schaefer, and K. Wang. 2009a. Evaluation of pervious concrete workability using gyratory compaction. American Society of Civil Engineering, *Journal of Materials in Civil Engineering* 21 (12, December): 764–770.
- Kevern, J. T., V. R. Schaefer, and K. Wang. 2009b. Predicting performance of pervious concrete using unit weight. In *Proceedings of the 2009 NRMCA Concrete Technology Forum—Focus on Performance Prediction*. Cincinnati, Ohio.
- Kevern, J. T., V. R. Schaefer, and K. Wang. 2009c. The effect of curing regime on pervious concrete abrasion resistance. *Journal of Testing and Evaluation* 37 (4): JTE101761.
- Kevern, J. T., K. Wang, and V. R. Schaefer. 2010. The effect of coarse aggregate on the freeze-thaw durability of pervious concrete. *American Society of Civil Engineers Journal of Materials in Civil Engineering* 22 (5, May).
- Kosmatka, S. H., B. Kerkhoff, and W. C. Panarese. 2002. *Design and Control of Concrete Mixtures*. EB001. Skokie, Illinois: Portland Cement Association.
- Mata, L. A. 2008. Sedimentation of pervious concrete pavement system. Ph.D. dissertation, Raleigh, North Carolina.
- Mehta, P. K. and P. Monteiro. 1993. *Concrete: Structure, Properties, and Materials*. Englewood Cliffs, New Jersey: Prentice Hall.
- Meininger, R. C. 1988. No-fines pervious concrete for paving. *Concrete International* 10 (August): 20–27.
- Mississippi Concrete Industries Association (MCIA). 2002. *Pervious Concrete: The Pavement That Drinks*, <http://www.mississippiconcrete.com/downloads/pervious.pdf> (10 September, 2010)
- Montes, F., S. Valavala, and L. M. Haselbach. 2005. A new test method for porosity measurements of portland cement pervious concrete. *Journal of ASTM International* 2 (1) 13.
- National Ready Mixed Concrete Association (NRMCA). 2005. *Text Reference for Pervious Concrete Contractor Certification*. NRMCA Publication #2PPCRT. Silver Spring, Maryland.
- Neithalath, N., W. J. Weiss, and J. Olek. 2003. *Development of Quiet and Durable Porous Portland Cement Concrete Paving Materials*. Final Report, The Institute for Safe, Quiet, and Durable Highways. 179 pp., <http://www.ntl.bts.gov/lib/24000/24600/24636/SQDH2003-5.cfm>

- Olek, J., W. J. Weiss, N. Neithalath, A. Marolf, E. Sell, and W. D. Thornton. 2003. *Development of Quiet and Durable Porous Portland Cement Concrete Paving Materials*. Final Report SQDH 2003-5. West Lafayette, Indiana: Purdue University.
- Othman, H. M. and L. Hardiman. 2005. Characterization of the clogging behaviour of double layer porous asphalt. *Eastern Asia Society for Transportation* 6:968–980.
- Pezzaniti, D., S. Beecham, and S. Kandasamy. 2008. Influence of clogging on the effective life of permeable pavements. *Water Management*. Australia.
- Propex Concrete Systems. *FIBERMESH 300 Product Data Sheet*, <http://www.fibermesh.com/downloads/Fibermesh%20300.pdf> (8 August 2008)
- Rasmussen, R., S. Garber, G. Fick, T. Ferragut, and P. Wiegand. 2008. *How to Reduce Tire Pavement Noise: Interim Better Practices for Constructing and Texturing Concrete Pavement Surfaces*. Pooled Fund TPF-5(139), July. <http://www.ctre.iastate.edu/reports/cpsc-interim.pdf> (12 August 2011)
- Rasmussen, R. O., R. Sohaney, P. Wiegand, and D. Harrington. 2011. *Concrete Pavement Surface Characteristics Program Part3: The Language of Noise and Quieter Pavements*. Tech Brief from the National Concrete Pavement Technology Center (National CP Tech Center), Ames, Iowa: Iowa State University.
- Schaefer, V. R., K. Wang, M. T. Suleiman, and J. Kevern. 2006. *Mix Design Development for Pervious Concrete in Cold Weather Climates*. Report from the National Concrete Pavement Technology Center, Ames, Iowa: Iowa State University, http://www.intrans.iastate.edu/reports/mix_design_pervious.pdf (13 August 2011)
- Schaefer, V. R., J. T. Kevern, and K. Wang. 2008. A retrospective look at the field performance of Iowa's first pervious concrete sections as of spring 2008. In *Proceedings of the 2008 NRMCA Concrete Technology Forum—Focus on Pervious Concrete*, Denver, Colorado. CD-ROM.
- Schaefer, V. R., J. T. Kevern, and K. Wang. 2010a. Pervious concrete overlay design, construction and performance. In *The Second International Conference on Sustainable Construction Materials and Technologies* 2:789–800. 28–30 June, Ancona, Italy.
- Schaefer, V. R., J. T. Kevern, B. Izevbekhai, K. Wan, H. E. Cutler, and P. Wiegand. 2010b. Construction and performance of the pervious concrete overlay at MnROAD. *Transportation Research Record: Journal of the Transportation Research Board (TRB), Concrete Materials 2010* (2164): 82–88.
- Stakston, A. D. and H. U. Bahia. 2003. *The Effect of Fine Aggregate Angularity, Asphalt Content, and Performance Graded Asphalts on Hot Mix Asphalt Performance*. WisDOT Highway Research Study 0092-45-98. Madison, Wisconsin: Wisconsin Department of Transportation Division of Transportation Infrastructure Development.
- Suleiman, M. T., J. T. Kevern, V. R. Schaefer, and K. Wang. 2006. Effect of compaction energy on pervious concrete properties. In *Proceedings of the 2006 NRMCA Concrete Technology Forum—Focus on Pervious Concrete*, Nashville, Tennessee. CD-ROM.
- Tan, S. A., F. T. Fwa, and C. T. Han. 2001. Clogging evaluation of permeable bases. *Journal of Transportation Engineering* 129 (3, May).
- Taylor, P. C., S. H. Kosmatka, and J. F. Voigt (eds.). 2006. *Integrated Materials and Construction Practices for Concrete Pavement: A State-of-the-Practice Manual*. Report from the National Concrete Pavement Technology Center and Federal Highway Administration, Ames, Iowa: Iowa State University. FHWA Publication No. HIF-07-004), www.cptechcenter.org/publications/imcp/ (13 August 2011)

- Tennis, P. D., M. L. Leming, and D. J. Akers. 2004. *Pervious Concrete Pavements*. EB302. Skokie, Illinois: Portland Cement Association; Silver Spring, Maryland: National Ready Mixed Concrete Association.
- Tikalsky, P., V. Schaefer, K. Wang, B. Scheetz, T. Rupnow, A. St. Claire, M. Siddiqi, and S. Marquez. 2007. *Development of Performance Properties of Ternary Mixtures: Phase 1 Final Report*. Report from the National Concrete Pavement Technology Center, Ames, Iowa: Iowa State University. FHWA Publication No. HIF-07-004.
- Tong, B. 2011. Clogging effects of portland cement pervious concrete. M.S. thesis, Iowa State University, Ames, Iowa.
- U.S. Environmental Protection Agency (U.S.EPA). 1999. *Storm Water Technology Fact Sheet Porous Pavement*. EPA 832-F-99-023, September.
- U. S. Environmental Protection Agency (U.S.EPA). 2004. *National Menu for BMP Practices Post-Construction Storm Water Management*, http://cfpub.epa.gov/npdes/stormwater/menuofbmps/pdf/final/sec-5_new.pdf (12 August 2011)
- Vorobieff, G. and E. Habir. 2005. *No Fines Concrete Research Project Overview of Stages 1 and 2*. Interim Report R04-A018, Australian Operations and Services Directorate.
- Vorobieff, G. and G. Donald. 2008. *A Safe Highway Driving Surface Using an Open Graded Concrete*. Final Report, Australian Roads and Traffic Authority, RTA Pavement Structures Section, ISCP9008.
- Wang, K., J. K. Cable, and G. Zhi. 2006a. Evaluation of pavement curing effectiveness and curing effects on concrete properties. *Journal of Materials in Civil Engineering* 18 (3).
- Wang, K., V. R. Schaefer, J. T. Kevern, and M. T. Suleiman. 2006b. Development of mix proportion for functional and durable pervious concrete. In *Proceedings of the 2006 NRMCA Concrete Technology Forum—Focus on Pervious Concrete*, Nashville, Tennessee. CD-ROM.
- Wang, K., S. Shah, and J. Voigt. 2008. Self-consolidating concrete for slip-form construction: Properties and test methods. In C. Miao, G. Ye, and H. Chen (eds.). *Proceedings of Advances in Civil Engineering Materials, The 50-year Teaching and Research Anniversary of Prof. Sun Wei*, 161–172. 15 October, 2008, Nanjing, China. RILEM Publications, ISBN: 978-2-35158-098-1.
- XYPEX Chemical Corporation. 2000. XYPEX ADMIX C-1000 product data sheet. *Concrete Waterproofing*, 07160 Rev-04-00, www.xypex.com (13 August 2011)